

DECLASSIFIED IN FULL

REPORT OF THE DEFENSE SCIENCE BOARD

September 1958

Report on Limited War
Volume 3



Office of the Under Secretary of Defense
for Acquisition, Technology, and Logistics
Washington, D.C. 20301-3140

DECLASSIFIED IN FULL

DECLASSIFIED IN FULL

This report is a product of the Defense Science Board (DSB).

The DSB was established in 1956 as an advisory board to the Secretary of Defense. Statements, opinions, conclusions, and recommendations in this report do not necessarily represent the official position of the Department of Defense (DoD). The report was cleared for open publication by the Washington Headquarters Services Records and Declassification Division on February 24, 2011

This report is unclassified and cleared for public release.

DECLASSIFIED IN FULL

DECLASSIFIED IN FULL
Authority: EO 13526
Chief, Records & Declass Div, WMS
Date: FEB 24 2011

~~SECRET~~

DSB 220/3

DECLASSIFIED IN FULL
Authority: EO 13526
Chief, Records & Declass Div, WHS
Date: FEB 24 2011

VOLUME III

FINAL REPORT OF THE
TASK GROUP ON LIMITED WAR

DEFENSE SCIENCE BOARD

~~This document contains information affecting the national defense of the United States within the meaning of the Espionage Laws, Title 18, U.S.C., Sections 793 and 794. The transmission or the revelation of its contents in any manner to an unauthorized person is prohibited by law.~~

Office of the Assistant Secretary of Defense
Research and Engineering
Washington 25, D. C.

1 September 1958

Members of Task Group:

L. Eugene Root
Leslie E. Simon, Maj. Gen., USA (Ret.)
L. T. E. Thompson, Chairman
Warren E. Thomson, Secretary

For the Task Group:

L. T. E. Thompson

L. T. E. Thompson

~~SECRET~~

Page determined to be Unclassified
Reviewed Chief, RDD, WHS
IAW EO 13526, Section 3.5
Date: FEB 24 2011

~~SECRET~~

DECLASSIFIED IN FULL
Authority: EO 13526
Chief, Records & Declass Div, WHS
Date: FEB 24 2011

FOREWORD

This volume contains reference material considered by the Defense Science Board's Task Group on Limited War in preparing Volume 1 of its report. The contributions of Brigadier General S. R. Shaw, USMC, Major General R. P. Swofford, Jr., USAF, Major General Robert J. Wood, USA, Dr. William F. Whitmore and Mr. Robert H. Shatz were prepared at the request of the Task Group.

~~SECRET~~

Page determined to be Unclassified
Reviewed Chief. RDD. WHS
IAW EO 13526, Section 3.5
Date: FEB 24 2011

~~CONFIDENTIAL~~

DECLASSIFIED IN FULL
Authority: EO 13526
Chief, Records & Declass Div, WHS
Date: FEB 24 2011

CONTENTS

	<u>Page</u>
Foreword.	111
Research and Development to Increase Limited War Capabilities. Brig. Gen. S. R. Shaw, USMC	1
Research and Development Program Notes on Limited War Operations Maj. Gen. R. P. Swofford, Jr., USAF	11
Projects and Areas Expected to Increase Limited War Capabilities. Maj. Gen. Robert J. Wood, USA	15
A Research Program for the Improvement of Limited Warfare Capabilities Robert H. Shatz, Cornell Aeronautical Laboratory, Inc.	25
Naval Ships, Landing Craft and Amphibians in Limited Warfare Operations. Office of the Chief of Naval Operations	53
Notes on Warfare for Limited Objectives William F. Whitmore, Bureau of Ordnance, Department of the Navy	59
Department of Defense Cold-War Intelligence Requirements for a Contested Free-World Country Office of the Assistant to the Secretary of Defense for Special Operations	65
"Pacification" in Vietnam Col. Edward G. Lansdale, Deputy Assistant to the Secretary of Defense, Special Operations	69
The Lao National Army - Its Role in Defeating Communist Subversion in Laos. Rufus Phillips, Office of the Assistant to the Secretary of Defense for Special Operations	105

~~CONFIDENTIAL~~

Page determined to be Unclassified
Reviewed Chief, RDD, WHS
IAW EO 13526, Section 3.5
Date: FEB 24 2011

RESEARCH AND DEVELOPMENT TO INCREASE

LIMITED WAR CAPABILITIES¹

Page determined to be Unclassified
Reviewed Chief, RDD, WHS
IAW EO 13526, Section 3.5
Date: FEB 24 2011

Brig. Gen. S. R. Shaw, USMC

I would like to emphasize the Marine Corps convictions:

a. That items not intended for use in the nuclear deterrent of all-out general war fit into the "limited war" category.

b. That the capability to efficiently conduct "limited war" in itself is a large non-nuclear deterrent to all-out nuclear war.

c. And that "limited war" forces will conduct whatever war is fought by the remnants after the all-out nuclear exchange of a nuclear general war.

The foregoing facts indicate that the U. S. capability to conduct "limited war" requires as high a priority as any other capability.

Areas in Which Increased Emphasis Would Create Increased Limited War Capabilities (Enclosure 1)

Temperature Standards for Equipment

A general area in which great improvement in the time and cost of developing equipment can be effected is in the specifications for minimum and maximum temperatures at which equipment must operate. (These remarks do not apply to aerial equipment which must be used in the extreme of temperatures found at great altitudes.)

It is generally standard practice to demand that equipment operate within temperatures of -65°F to 125°F. A look through any standard atlas indicates that a -65° is a temperature that occurs in a very few places

¹Memorandum, "Research and Development to Increase Limited War Capabilities," 12 February 1958, from Brig. Gen. S. R. Shaw, USMC, to Dr. L. T. E. Thompson, and enclosures.

on very few days in the year. The probabilities that U. S. forces would be conducting significant combat in those places on those days is remote in the extreme. Yet for such a remote possibility, we now pay an inordinate price in time and money to find out, usually, that we cannot meet the specification and must accept a waiver. Since men, normally, at less than -40°F can do little more than stay alive against the assault of the elements, this would seem a reasonable lower limit for standard nonaerial equipment. Such a determination would certainly expedite the development and production of new equipment and reduce the cost.

Communications

With our formations widely separated--many times, moving rapidly--and requiring intimate coordination between ground and air units, radio will be our principal means of communication. We will no longer use miles and miles of telephone wire. The reliance on radio creates an urgent requirement for lighter, more reliable radio systems capable of operating over greatly increased distances.

Intelligence

Use of widely separated, fast-moving tactical units may put us in the position of being able to fight more rapidly than we can find the enemy or determine his capabilities. This generates a requirement for great improvement in rapidly getting and using intelligence about the enemy.

Mine Detection

The communists use land mines in great quantity. Our methods of finding and identifying minefields are rather primitive--and usually painful. We usually blow someone up as the first indication. We need a means of locating minefields before we step on one of the mines. Perhaps some technique of photography, by changes in the photographed appearance of disturbed vegetation, would clearly identify the pattern of a minefield.

Blast Alleviation

We have an unsolved problem in the jet blast of missiles. The jets of gas dig holes in the ground around the missile launchers and we must find a means to protect the soil or dissipate the blast. When the vertical take-off aircraft currently under development become available, we will have another similar problem.

Individual Protective Armor

We now have armor. It is good as far as it goes. It protects against low-velocity fragments--shrapnel. What we need now represents a big jump in this field. We need armor against rifle and machine-gun bullets and armor against small fragments of extremely high velocity.

The present armor is designed to protect the vital parts, to reduce the probability of a hit or wound resulting in death. We need to extend this armor to the arms and legs to reduce the probability that a man will become a casualty at all. This would help us maintain more men in action in two ways: It would reduce the number removed from action because they became casualties; and it would reduce the number removed from action to care for and evacuate the casualties. The armor to fulfill this requirement must be light enough, flexible enough and durable enough for long periods of wear. If it is to cover most of the Marine, it must be ventilated enough to permit great physical effort even in hot, humid climates.

Rations

The new method of fighting places a premium on reducing the supply problem. One of our biggest problems in this area--one that is with us every day--is food. Our present rations take great bulk. It takes great effort and much time to distribute the bulk on the battlefield. We have two types of rations for use by assault forces, both of which are so dull, tasteless and hard to eat that exhausted men often eat only the meat portion, discard the remainder and go to sleep rather than try to finish the ration. As a result, men who do not eat all their rations fail to consume sufficient food to permit them to recover from their exhaustion. They lose their resiliency and ability to bounce back. Tired men in combat take more casualties than they should.

We need an assault ration weighing less than three pounds that is so good that troops will eat it all and so nourishing that they can exist on it for a week or more.

Military Vehicles

During recent years our military vehicles have undergone a number of refinements, each of which has produced a heavier, more complicated and more expensive piece of equipment. More specifically, power trains for military vehicles have become more complicated and heavier and require greater precision in building and repair and more fuel to make them go. In short, we have given birth to an enormous logistic burden. This burden is measured in rivers of fuel, thousands of tons of steel for packing and transporting the fuel, and extra dollars and manpower required to produce the precision engineering and effect necessary maintenance. As an example, one of our new amphibious vehicles requires a motor capable of 850 horsepower, of which 250 horsepower is required to run the transmission.

The new method of fighting that the Marine Corps will use requires a totally new approach to military vehicles and their power trains. More of our vehicles need to be helicopter-transportable, and all need motors and transmissions that will reverse the recent trend. We need rugged, reliable, lightweight, simple and economical power trains for our vehicles and we need them badly.

Attack of Hostile Surface-to-Air Missile Systems

In the not distant future, enemy anti-air missile systems may make manned aircraft attacks in areas protected by such systems too costly to undertake. This would be serious in any form of war, but particularly so in limited war where the possible use of stand-off missiles with nuclear warheads is ruled out.

This capability of enemy anti-air missile systems requires active measures to counter it. The development of something like an electronic smoke, to blank out the hostile radars and cover the coordinated approach of manned attack planes, offers a very attractive solution. The Army Chemical Warfare Service has done some work in this field. A very promising item is the ELOR3 fuel made up in .30-micron glass, aluminum-coated fibers. One gram had the effect of 25 B-29 aircraft on a radar screen. To date, the experiments have been small and at short range. What is needed is something like the POLARIS loaded with this type of material to blanket the enemy radars. An effective, reliable development of this sort could be a real strategic surprise.

With the battlefield becoming littered with surveillance radars, mortar-locating radars, and other electronic control items, a rapid development of this type could find very profitable use in other than the attack of anti-air missiles.

~~SECRET~~

DECLASSIFIED IN FULL
Authority: EO 13526
Chief, Records & Declass Div, WHS
Date: FEB 24 2011

Current Marine Corps Research and Development Projects Expected To
Produce Improved Weapons and Equipment for Limited War
(Enclosure 2)

TERRIER Missile System (NC-007001)

This project provides for the investigation and study of the land-based weapon system elements required to utilize the range and altitude capabilities of the improved TERRIER missile, within the boundary conditions of mobility and portability. As elements and their characteristics are determined, prototypes of equipment are to be developed for integration into the weapons system employing the TERRIER missile.

Missile Booster Blast Alleviation (NC-007002)

This project provides for an engineering study to determine the critical factors which define the rocket blast problem area. The most feasible approach to the problem solution will be determined from these factors and suitable prototypes will be developed for evaluation.

HAWK Missile System (NC-007003)

This project provides for Marine Corps participation in the Army HAWK program (D/A 516-04-006). This system will fulfill a requirement for an effective weapon capable of defeating high-speed, low-flying tactical aircraft. The Army is developing the basic system, which will be mobile. Marine Corps participation provides for the development of additional or substitute items of equipment required for an assault mode of operation. All equipment required for the assault mode will be helicopter-transportable.

REDEYE Missile System (NC-007004)

This is a joint project with the Army for the development of an effective, man-portable, antiaircraft weapon to be employed by forward elements of an assault force against low-flying support-type aircraft. It will be a bazooka-type weapon, employing an infrared homing head similar to that used on the SIDEWINDER missile.

Amphibious Cargo Packaging (NC-056002)

This project provides for active participation in the Bureau of Supplies and Accounts Project NT-003-016 for the development of improved packaging material and techniques for use in efficient and expeditious landing of supplies in amphibious operations. Particular emphasis is on packaging for resupply of widely dispersed units by helicopter.

~~SECRET~~

~~SECRET~~

DECLASSIFIED IN FULL
Authority: EO 13526
Chief, Records & Declass Div, WHS
Date: FEB 24 2011

Improved Shore Party Equipment (NC-056006)

This project provides for the modification of existing engineer-type equipment and development of new items required for support of widely separated tactical units. Engineer-type equipment is being sectionalized so that the sections can be helicopter-lifted separately and reassembled in the area where the equipment is to be used.

Aerial Delivery Equipment (NC-056007)

This project provides for development of containers and descent devices to provide an economical and accurate means of resupply to widely separated units using low-flying, high-performance tactical aircraft. The major effort under this project is directed at development of a "rotachute" descent device which uses rotating blades to reduce the speed of fall of dropped supplies.

Remotely Emplaced Land Mines (NC-060002)

This project provides for the development of antitank mines which can be dropped from an airplane to establish protective minefields around a landing area prior to the actual landing to reduce the probability of an enemy armored attack during the critical landing period. The mines under development are dropped in clusters, separate in flight and bury themselves upon striking the ground.

Improved Flame Munition (NC-060006)

This project provides for the development of improved flame throwers, an improved flame gun and improved thickeners for incendiary fuels. This is a joint project with the Army.

Direct Support Artillery Weapon (NC-060016)

This is a joint project with the Army for the development of a lightweight, helicopter-transportable, direct support artillery weapon of the boosted-rocket type. Equipment under development includes a lightweight rocket launcher and boosted rocket-type ammunition.

Radio Set AN/TRC-27 (NC-062005)

The development of the basic radio relay equipment AN/TRC-27 has been completed and the equipment approved for service use. This project provides for completion of development of small, simple, drop-out and insert units and a transistorized 8-channel multiplexing system. The drop-out and insert unit will eliminate the requirement for complete multiplexing equipment at relay stations, and the new multiplexing system will increase the over-all system capability as it will replace the present 4-channel multiplexing system.

~~SECRET~~

~~SECRET~~

Portable Facsimile Equipment (NC-062011)

This project provides for the development of a lightweight easily operated device capable of transmitting and receiving line sketches, overlap, diagrams, charts and written material. The equipment will be complete with portable power source and will transmit and receive copy over normal tactical wire and radios.

Ultrasonic Communications (NC-062014)

This project provides for development of simple, rugged, miniature equipment which may be easily used by individual riflemen to receive and transmit signals at ranges greater than those permitted by voice under normal combat noise conditions. Equipment planned consists of a hearing-aid-type device capable of detecting ultrasonic signals and a simple device such as a whistle to generate the signal.

Man-Pack Tactical Radio (NC-062017)

This project provides for the development of a portable radio set for use by helicopter-lifted assault forces to replace radio sets AN/PRC-8, -9, -10. Wide separation of tactical units creates a requirement for a range of at least 15 miles for this type equipment. Present equipment is satisfactory from a size and weight standpoint but inadequate in range.

Armored Vehicle - Infantry Communications (NC-062018)

This project provides for the development of a simple, rugged system to replace the telephone and cable system now used between infantry personnel and supporting armored vehicles. It is anticipated that the magnetic induction principle will provide a suitable short-range, relatively secure means of communication.

UHF 1750 Channel Man-Pack Radio (NC-062019)

This project provides for the development of portable UHF ground-to-air communication equipment for use in close air support control. The equipment is to be capable of simple omnidirectional voice communication at line-of-sight ranges up to 100 miles. The physical characteristics are to be similar to the standard series of man-pack radio sets.

Communications Systems Study (NC-062020)

This project provides for a study of Marine Corps tactical communication requirements to determine the information needed at various echelons and to recommend the equipment required to disseminate this information. This will include requirements for transmissions and/or reception of printed matter, voice, CW, etc., at the various command levels.

~~SECRET~~

~~SECRET~~

Radar Set AN/MPS-21 (NC-062401)

This project provides for development of a search radar capable of movement in amphibious vehicles and craft or by helicopter and capable of rapid installation to provide for detection of high-performance aircraft during the early stages of amphibious operations. Equipment under development consists of a radar capable of providing 3-dimensional information on high-speed, high-altitude combat aircraft at effective ranges up to 200 nautical miles.

Height-Finding Radar (NC-062409)

This project provides for the development of a lightweight, rugged, waterproof height finder which will provide 3-dimensional information on aircraft in those areas and under those conditions where larger radar cannot be used. Present emphasis is on the development of a height-finding receiver for use in conjunction with lightweight air-search radar AN/UPS-1. An alternate approach provides for development of a radar using the mono-pulse tracking radar technique.

Locating and Guidance System (NC-062416)

This project provides for development of equipment to permit the location and marking of positions (including front lines), assembly areas and targets which are to be taken under attack during low-visibility conditions. The equipment is to provide a means of accurately locating a reference point or position without regard to terrain or visibility and provide an accurate ground reference system to mobile or airborne units.

Remote Sensing Devices (NC-062418)

This project provides for development of equipment which can be emplaced behind enemy lines and can detect moving vehicles and personnel. This information is to be automatically transmitted to receiving units located near the front lines.

Battlefield Identification System (NC-062422)

This project provides for development of equipment which will permit positive recognition and identification of friendly personnel or vehicles when detected by landing forces or supporting aircraft. This will eliminate the requirement for visual identification of isolated friendly forces by support aircraft and provide a more positive means of identifying returning patrols and adjacent units which are physically separated.

Man-Transportable Mortar Locator (NC-062423)

This project provides for development of a simple, lightweight man-transportable means of detecting and locating mortar and gun positions. The equipment to be developed is to replace the heavier AN/KPQ-1 radar and will include a capability for simultaneous handling of multiple targets.

~~SECRET~~

~~SECRET~~

DECLASSIFIED IN FULL
Authority: EO 13526
Chief, Records & Declass Div, WHS
Date: FEB 24 2011

Marine Corps Tactical Data System (NC-062425)

This project provides for the development of a system to collect, store, rapidly disseminate and display target information so that it can be readily interpreted by those exercising command during amphibious operations. The system is to be helicopter-transportable and capable of exchanging information with data systems employed by other services.

Personnel Detector and Locator (NC-062427)

This project provides for the development of a lightweight man-transportable device for detecting and locating moving personnel and vehicles under all conditions of visibility. The equipment is to have the same capabilities as the radar set AN/TPS-21 but is to be only one-half as heavy. Transistors will be used wherever possible, and the equipment will operate from batteries rather than using an engine generator.

Radar Information Central (NC-062428)

This project provides for improving and repackaging the AN/MSQ-3 which is the ground terminal equipment for the Airborne Early Warning Radar System. The planned improvements will include repackaging for helicopter transport and increasing the range capabilities.

Multi-target Close Air Support Control System (NC-062429)

This project provides for the development of the ground portion of a close air support guidance system which can permit simultaneous control of more than one aircraft against one or more ground targets. This equipment will replace the AN/TPQ-10, which can control only one aircraft at a time and requires the radar during the entire strike. Computers and information storage techniques will be used to increase the number of aircraft and targets that can be handled simultaneously.

Electronic Warfare for Amphibious Operations (NC-062901)

This project provides for investigations to determine countermeasure requirements and the development of tactical, active and passive countermeasure equipment. Particular emphasis will be placed on devices to detect and counteract battlefield surveillance equipment, mortar locators and close-support guidance systems.

LACROSSE Missile System (NC-068004)

This is a joint Army-Marine Corps development to provide an artillery-support-type missile capable of precision destruction attacks with decisive power on appropriate targets at ranges up to 30,000 meters. The Army is developing the basic system under Project 516-05-002. This project provides for Marine Corps participation in the Army development to ensure inclusion of operational and physical characteristics unique to Marine

~~SECRET~~

~~SECRET~~

Corps requirements. The more important of these characteristics include helicopter transportability and the flexibility necessary to enable the use of a ballistic version of the missile.

Personal and Protective Equipment (NC-258001)

This project provides for development of improved body armor and associated equipment required to maintain the maximum number of men effective on the battlefield. Subtasks include improvement to the standard armored vest and lower torso armor and development of armored footwear and cold-weather helmet liners.

~~SECRET~~

~~SECRET~~

DECLASSIFIED IN FULL
Authority: EO 13526
Chief, Records & Declass Div, WHS
Date: FEB 24 2011

R&D PROGRAM NOTES ON LIMITED WAR OPERATIONS²

Maj. Gen. R.P. Swofford, Jr., USAF

Successful deterrence of limited war, as in the general case, depends upon possession by the United States of adequate forces and a manifest (to the enemy) determination to use them in suppression of local aggression. In addition, it is the Air Force view that USAF requirements in any limited situation can and should be met with forces provided for the contingency of general war.

It is therefore Air Force policy that USAF forces shall be organized, equipped and trained for flexible, rapid and decisive use in the suppression of local aggressions without significant impairment of their ability to wage general war.

Theater air forces, although deployed for general war, may rapidly be applied to local situations. The Tactical Air Command has organized and trained a composite air strike force for immediate dispatch to threatened areas in support of our deployed forces and our allies. Strategic Air Command bombers are equipped to apply a wide range of weapons against local aggression in any area of the Free World. The Air Force airlift capability enhances strategic mobility of all combat armies.

Air Force missiles increase our strength for general deterrence and, at the same time, give the manned forces more freedom of action to cope with local aggression with the least displacement of the general war deployment.

In reviewing both present and future R&D effort within the above framework, certain areas of endeavor, while necessary to the improvement of our over-all capability, would seem to offer especially attractive pay-offs when viewed from the standpoint of limited operations. Specifically, these fall into three general categories.

²Memorandum, "R&D Program Notes (Limited War Operations)," 12 February 1958, from Maj. Gen. R.P. Swofford, Jr., Director of Research and Development, Office, Deputy Chief of Staff, Development, Department of the Air Force, to Defense Science Board Task Group on Limited War, attention: Dr. L. T. E. Thompson.

~~SECRET~~

~~SECRET~~

(1) In the field of ordnance, the development of small nuclear warheads in the fractional and small kiloton range, together with a flexible range of fusing, both VT and contact. This line of endeavor would allow greatly increased selectivity in application and effort not at present found in this weapon family.

(2) Acceleration of development of a true all-weather capability in the control of tactical air units and in the delivery of air ordnance-- especially as applied to smaller, fast vehicles such as fighter-bombers-- and theater reconnaissance would enhance our capability in rapidly and effectively dealing with local situations.

(3) The tactical air-to-surface missile, having interchangeable high-explosive (HE) and nuclear capability and very small circular probable error (CEP), is a necessary adjunct to the small nuclear warhead requirement.

A list of current R&D projects follows:

(1) R&D Programs Under Way That Will Improve Air Force Capability to Wage a Limited War. The effort in the conventional weapons area (guns, ammunition, bombs, rockets, rocket launchers, bomb dispensers, fire bombs, warheads, etc.) is described below:

(a) Guns: Only product improvement on the 20mm M3982 and 20mm gun M61 (Gatling) guns is being funded at a low level in FY 1958 and will be continued in FY 1959.

(b) 20mm Ammunition (5129): A modest product-improvement program is continuing. The objectives are less susceptibility to cook-off, longer barrel life, improved projectile fillers, suitable armor-piercing incendiary tracer ammunition, and a better fuze. Some work is proceeding on Granite State, but test results are disappointing.

(c) Rocket Launchers (5150): A 38-round rocket launcher (LAU-2A) is being developed and will be tested in mid-1958. It fires the 2.75-inch air-to-ground rocket. It will augment the air-to-ground capability of the F-100, F-101 and F-105 aircraft. The LAU-3A (19-round launcher) is in production.

(d) Air-to-Surface Missile for Tactical Aircraft (321A): A project has been initiated to deliver with great accuracy (30 feet CEP) against ground targets a tactical missile capable of carrying interchangeably a nuclear warhead or a warhead carrying 250 pounds of HE. Availability will be dictated by the funding picture.

(e) Remote Electric Bomb Arming (5012): Equipment that will electrically control the functioning of the T905, T906, T908, T910 and T768 electric bomb fuzes is being developed. This will provide a means for remotely setting the arming and impact delays of the fuzes at any time during flight. Air Force decision on ultimate use of this equipment will be made after high-speed tests of the mechanical fuzes.

12
~~SECRET~~

~~SECRET~~

(f) Electric Bomb Fuzes (5111): The T905 fuze test has been completed. The T906 and T908 (long delay) fuzes are under development and will be tested in mid-1958.

(g) Aerial Mines (Doanbrook)(5045): Development of anti-locomotive land mines and fuzes is proceeding. The program is expected to be completed in 1958.

(h) VT Bomb Fuzes (5110): Development and test of VT (proximity) fuzes (T750 proximity-mechanical, T768 proximity-electric, and T796 proximity-tail) which will be suitable throughout the full range of operations for the new series of demolition and chemical bombs will be completed this year.

(i) MARFRAG (antipersonnel bomb) and Dispenser (5113): This program (development and test) should be completed in mid-1958.

(j) Fire Bomb (5134). Development and test of an improved fire bomb (BLU-1) capable of operation under supersonic speed conditions are under way. The program is scheduled for completion early in 1959.

(2) Weapon Systems:

(a) The F-105 is undergoing development to provide an all-weather navigation and bombing system for special weapons; this precise navigation and bomber capability will permit all-weather operation by seeking out targets and attacking by visual means. These attacks can then employ air-to-surface missiles, gunfire, conventional bombs and the BW-CW (biological- and chemical-warfare) agents.

(b) The F-100 series aircraft have the same capability for delivery of conventional weapons as the F-105 but are limited to visual delivery only, as no means of finding and attacking during darkness and adverse weather is provided.

(c) A vertical/short take-off and landing weapon system (V/STOL) capable of operating without fixed sites is under engineering study and investigation during Phase I of development. This weapon system, under development by the U. S. Navy under contract with Bell Aircraft Corporation, will be capable of delivering special weapons, conventional weapons, and air-to-surface missiles in all types of weather.

(d) AVRO of Canada is proposing a VTOL vehicle for tactical use. This proposal is being monitored closely and the present development engineering effort is being partly reoriented to provide a useful military weapon; AVRO has been requested to propose a fighter-bomber configuration.

(e) Serious consideration is being given to follow-on procurement of the C-130 aircraft series. A model improved version of the C-130 incorporating boundary layer control (BLC) has been proposed as a

~~SECRET~~

~~SECRET~~

segment of the FY 59 procurement cycle. The C-103, BLC-equipped aircraft, would greatly enhance the capability of the Air Force to support the Army in assault operations and will materially decrease the Air Force dispersed-missile-site problems. BLC will improve the STOL characteristics of the C-103 approximately 50 percent. Air-head operation from hastily prepared fields measuring less than 1200 feet is a reality. For example, midpoint landing and take-offs can be accomplished in less than 700 feet or little more than seven times the length of the aircraft. At the present time, the program appears contingent upon the added budget increment.

Our planning for the future has not taken a major departure from the air weapons as we know them today, or from those currently proposed (VTO and V/STOL), except that a requirement is emerging for the capability to operate from dispersed, hastily prepared sites and to deliver weapons in any type of weather and with a high degree of accuracy. General operational requirements (GOR) (Air Force) are well organized and thought out for the limited war as well as for general war. The limiting factor in achieving our requirements has been a lack of funds available to fulfill these GORs. A list of tactical GORs, reflecting current status, follows:

<u>GOR No.</u>	<u>System</u>	<u>Date</u>	<u>Status</u>
5	TAC AC&W	Jan 52	In development
126	TAC Tanker	Nov 55	No action
128	Heavy TC	Nov 55	No action
130	Assault TC	Nov 55	No action
134	TAC Recce	Jan 56	Study
145	VTOL TC	Feb 56	No action
154	TAC Bomber	Jul 56	No action
161	SREB	Jul 57	Study
166	ASM	Oct 57	Study plus preliminary engineering
---	TAC Fighter- Bomber (V/STOL)	--- --	Coordination

~~SECRET~~

~~SECRET~~

DECLASSIFIED IN FULL
Authority: EO 13526
Chief, Records & Declass Div, WHS
Date: FEB 24 2011

PROJECTS AND AREAS EXPECTED TO INCREASE
LIMITED WAR CAPABILITIES³

Maj. Gen Robert J. Wood, USA

First I would like to make clear my belief that all projects now under development by the Army contribute directly to the limited war posture of the Army. Atomic weapons and possible CBR weapons may or may not be used in a limited war. If not used, the very presence of these capabilities will act as a restraint to the expansion of limited war.

Research and Development Areas
Where Increased Emphasis Would Probably Increase
Limited War Capabilities for the Army

- (1) An antimissile missile system that can destroy both ballistic and cruise-type missiles.
- (2) Air-transportable, surface-to-air defense missile systems for defense against aerial targets at all altitudes having both an atomic and a conventional capability and invulnerable to countermeasures. These systems will include highly mobile, air-transportable weapons for forward-combat-area air defense. They will also include the fire-direction systems needed to coordinate and provide data service to the weapons systems.
- (3) Highly reliable, air-transportable, surface-to-surface missiles having atomic capabilities, invulnerable to countermeasures and capable of rendering all-weather support. Development of a very accurate, helicopter-transportable, close support, surface-to-surface missile system with the foregoing characteristics but also capable of carrying either an atomic or nonatomic warhead to attack either area or point targets.

³Memorandum, "Lists of Projects and Areas to Increase Limited War Capabilities (U)," 12 February 1958, from Maj. Gen. Robert J. Wood, Deputy Chief of Research and Development, Department of the Army, to Warren E. Thomson, Office of the Assistant Secretary of Defense (Research and Engineering).

~~SECRET~~

~~SECRET~~

(4) Small- and large-caliber field-artillery free-rocket systems which are helicopter-transportable, very reliable and capable of carrying an atomic or nonatomic warhead for general support, firing on area-type targets.

(5) Air-transportable antitank guided missile which will have a high accuracy and a high kill probability on the heaviest armored enemy tanks.

(6) Lightweight, small-yield atomic weapons.

(7) Determination of means of applying atomic energy to military uses other than atomic weapons, such as atomic reactors and nuclear engines.

(8) Increased mobility of the Army by providing air vehicles, such as vertical take-off and short take-off and landing aircraft and the flying platform.

(9) Provision of means for rapid long-range surveillance, to include higher performance observation aircraft, reconnaissance drones and missiles.

(10) Provision of a combat surveillance system that will enable continuous surveillance of the battle area to provide information directly influencing ground combat.

(11) Provision of (a) a tactical operations center which will include the means for collection, analysis, storage and display at command posts of information on all operations, intelligence and logistical activity and (b) surveillance systems capable of quickly and accurately locating enemy land and airborne targets, assessing damage and rapidly disseminating information to using organizations.

(12) Provision of rapid, reliable and secure communications which are flexible and rugged and efficient in the use of the frequency spectrum and which possess maximum invulnerability to enemy countermeasures, natural interference and friendly radiation.

(13) Provision of the capability of operating against the massive use of electronic countermeasures.

(14) Equipment and techniques required for the maximum exploitation of all sources of intelligence, the improvement of counterintelligence operations, and the conduct of psychological and unconventional warfare operations.

(15) Air-transportable, highly mobile, counterartillery radar system capable of locating enemy artillery and registering friendly artillery.

(16) Lightweight, self-propelled artillery weapons capable of sustained combat. Development of ammunition of increased lethality.

~~SECRET~~

~~SECRET~~

(17) Development for those elements of the Army whose primary mission is sustained combat and which do not habitually require movement by air, of weapons, vehicles and equipment which are lightweight and mobile but which primarily provide the maximum capability for sustained combat.

(18) Lightweight, compact, rugged multipurpose small-arms weapon.

(19) Increasing the ground mobility of the Army by providing lightweight, compact, low-fuel-consumption vehicles, especially tanks and those types which occur in high density, and a family of lightweight, armored personnel and weapons carriers with improved cross-country mobility.

(20) Provision of superior equipment and development of new techniques for detecting and eradicating land mines.

(21) Provision of superior defensive capability in biological (BW) and radiological (RW) warfare, to include rapid prediction and detection of the effects of these agents and the protection of U. S. forces against them. Development of BW and RW offensive weapons as may be required.

(22) Determination of the effects of initial and residual nuclear radiation from atomic weapons upon U. S. forces.

(23) Provision of means for decreasing the time used in transporting material from the producer or zone of the interior depots to the user; for improving supply by air and over beaches; for reducing the time and effort involved in requisitioning and related stock accounting procedures; and for decreasing levels of supply in overseas depots.

(24) Aerial cargo-delivery equipment which will permit economical and accurate supply and resupply of Army forces.

(25) Development of superior rations and of lightweight and durable clothing and protective armor for the individual soldier.

(26) Development of greatly improved mapping techniques on a local and worldwide basis.

(27) Provision of a means of coping with and overcoming environmental handicaps which affect the Army's capability of waging war.

(28) Provision of new or improved means for the prevention and treatment of disease and injury anywhere in the world, especially under combat conditions.

~~SECRET~~

~~SECRET~~

DECLASSIFIED IN FULL
Authority: EO 13526
Chief, Records & Declass Div, WHS
Date: FEB 24 2011

List of Items Under Development That Are Expected to
Improve Limited War Capability of the Army

CARIBOU: Capable of operating from short, unimproved air strips, the CARIBOU is a three-ton-payload, light transport airplane that is being developed for forward-area support missions. Test models will be available in the spring of 1959 and production models in 1960.

MOHAWK: This joint Army-Navy development will provide a target-acquisition, combat surveillance aircraft specifically designed to carry electronic equipment while retaining a superior visual observation capability. Test models are to be available in the spring of 1959 and production models in 1960.

IROQUOIS: Developed to replace the H-19, the IROQUOIS (HU-1) is a turbine-powered, internally loading helicopter ideally configured for utility and medical evacuation missions. It carries a payload of 1000 pounds at a cruise speed of 100 knots. Test models are now in production and initial issue to using units will be made in 1959.

CHINOOK: This year the Army has initiated development of a three-ton-payload, internally loading helicopter to replace the MOJAVE (H-37). The CHINOOK will be turbine-powered and so designed to be suitable as a missile unit (LITTLE JOHN, HONEST JOHN and LACROSSE) transporter. It should be available for operational use in 1963.

Flying Jeeps: The flying jeep program is a high-risk project to develop a zero-ground-pressure vehicle capable of performing many of the missions now fulfilled by $\frac{1}{4}$ -ton trucks. By increased emphasis and at a higher risk, it would be possible to speed development considerably.

Flying Test Bed Projects: The Army is developing various flying test beds to investigate and determine the most suitable high-lift principles that may be utilized for vertical take-off and landing aircraft. Increased emphasis would speed the project and result in earlier development of actual prototypes.

High-Velocity Supply-Drop Aerial Delivery System: A system is being developed which will permit the aerial delivery of supplies at a high rate of descent. It will result in a minimum dispersal of supplies on the drop zone, reduced cost since smaller parachutes will be used, and greater drop accuracy. An interim system will be available this year and an improved system in FY 1960.

Multiple Helicopter Cargo Lift: This system is being developed to permit the transport of heavy cargoes utilizing two or more helicopters operating in unison.

~~SECRET~~

~~SECRET~~

Nuclear-Powered Logistical Carrier: A cross-country vehicle made up of a control car, 10 cargo cars and a nuclear power car, this vehicle will have a payload of 150 tons and a range without refueling of 50,000 miles. Large-diameter wheels (10 feet) provide the vehicle with cross-country mobility in sand, mud or snow.

Armored Carrier, 16,000 lb, T-113; Armored Carrier, 8,000 lb, T-114: These multipurpose carriers with high cross-country mobility provide protection from small arms, shell fragments, thermal effects and blast. These vehicles may be used as a carrier for personnel, or weapons, fire direction, command posts, communications center and cargo and as ambulances.

Cargo GOER: Logistical haulers with high mobility incorporating positive wagon steering, large-diameter wheels with low-pressure tires, exoskeletal body, capable of swimming inland waters and having a high ratio of payload to vehicle weight. The vehicles will be used to haul bulk cargo and fuel.

Family of Collapsible Containers, 500, 1,000, 6,000 and 10,000 gallons; Family of Conversion Kits to Permit Conversion of Cargo Vehicles to Bulk Petroleum Carriers; kits for 2½-ton and 5-ton cargo trucks, for railway boxcars, flatcars and gondolas, and for cargo aircraft: The objectives of this project are to develop petroleum-distribution equipment that will enable the Army to distribute petroleum in bulk to using equipment or units. Major development items include a family of collapsible containers, a family of conversion kits to permit conversion of cargo vehicles, aircraft and rail cars into bulk carriers and a family of lightweight high-volume transfer pumps. This equipment will materially increase the Army's petroleum-distribution capability and at the same time reduce personnel requirements.

Family of Rough Terrain Forklift Trucks, capacity 6,000, 10,000, 15,000 pounds; 5,000 pounds - Rough Terrain Forklift, High Flotation: The objective of this project is to develop materials-handling equipment that will speed up the delivery of supplies in rough-terrain areas such as would be encountered in over-the-beach or depot operations in unprepared areas. Aside from speeding up the movement of supplies, such equipment will materially reduce personnel requirements.

Self-propelled Gap Spanner (planned development); Armored Vehicle Launched Bridge; Mobile Assault Ferry: This highly mobile, self-propelled equipment is to provide a means of crossing water and other terrain obstacles by personnel and equipment. The self-propelled gap spanner is designed to bridge gaps and obstacles up to 90 feet. Individual bays are across launching tracks which are positioned across the gap by jato-operated cable. Bays are pinned together to form a bridge. Mobile assault ferry consists of four individual units with both automotive and hydrojet drive. The four units are formed at the water's edge or in the water to form the ferry.

~~SECRET~~

~~SECRET~~

Mobile Nuclear Power Plant: These mobile or trailer-mounted nuclear power plants for field army support will be used to fill the requirements for electrical energy, for mobile field hospitals, command and communications installations, radar systems and missile sites.

Light-Gun Tank T92, Medium-Gun Tank T95, Heavy-Gun Tank T95E4; Airborne Assault Weapon: This is a family of armored vehicles to perform the roles and missions of armor. The first three are tanks and the last is a self-propelled, air-transportable weapon to perform most of the roles of the current light- and possible medium-gun tank with reduced armor protection. The tanks with improved firepower, mobility and armor protection provide a higher capability in both limited and general war.

Development of Fire-Direction System for Vehicles; Gun Control System for Tanks; Cannon Development for Medium Tanks, 120mm; Gun Mount System for Vehicles; Power Converter for Track-Laying and Wheeled Vehicles; Terminal Ballistics Protective System (Siliceous-Core Armor); Power systems: Liquid-Cooled (Diesel-Multifuel), Air-Cooled (Diesel-Multifuel), Rotary and Combined Cycle (Engines); Dynamic Armor (Dot-Dash): This is component development to increase the capabilities and effectiveness of combat vehicles.

Self-Propelled Vehicles: T-195 for 105mm Howitzer, T-196 for 155mm Howitzer, T-235 for 175mm Gun, T-236 for 8-inch Howitzer: These are self-propelled carriages for field artillery which will be lighter and air-transportable in Phase III, will have greater operating range and require less maintenance time.

Field Artillery Direct Support Weapon (Moritzer); Division General Support Weapon; Corps Counterbattery Weapon: These are weapons of improved performance for direct support and general support of combat elements. Advances are being made in range, lethality and mobility of these weapons.

LITTLE JOHN; HONEST JOHN; LACROSSE; SERGEANT; Combat Group Field Artillery Missile "A"; Division Support Field Artillery Missile "B": These are surface-to-surface missiles to provide atomic and, where economically feasible, nonatomic fire support to Army units. New missiles will incorporate solid fuel, simplified control or guidance systems, greater flexibility and mobility.

Salvo Development Project: This is a long-range project to evaluate and determine the optimum caliber and configuration of a round of ammunition that will provide the infantryman with a much greater probability of kill for each round fired. Multiple bullets and small-caliber, high-velocity ammunition are being evaluated.

Antitank and Assault Weapons: These three weapons are under development in this area to provide the combat infantryman with a suitable weapon capable of defeating any tank likely to be encountered on the battlefield. These weapons will be used in secondary roles against fortified weapons positions and grouped personnel.

~~SECRET~~

~~SECRET~~

Light Assault Weapon: This is a rocket-propelled weapon utilizing a 24-inch-long Fiberglas packing case as a disposable launcher. The weapon will weigh approximately 4 pounds and will be effective to 250 yards. It will be employed as the antitank weapon of the rifle squad and as needed by other arms and services.

Recoilless Rifle T234: This will weigh approximately 30 pounds and will provide a 75-percent first-round hit probability at a range of 500 yards. This rifle will be employed by the rifle platoon.

DART: This wire-guided missile is being designed to give a 90-percent probability of first-round hit and a 90-percent probability of destroying or rendering unoperable the heaviest known tank with each hit. It is being designed to have a direct and indirect fire capability and will have a maximum range of 6,000 yards and a minimum range of 500 yards.

Battle Group Atomic Delivery System: This is a lightweight atomic delivery system, man-portable and vehicle-mounted, capable of projecting a 50- to 60-pound atomic warhead from 600 yards up to 5,000 yards. The warhead yield will be between 10 and 100 tons.

Universal Firing Device (UFD), Tactical Atomic Demolition Munition (TADM), Special Atomic Demolition Munition (SADM): This is a firing device with wire and radio remote command firing signals which will be compatible with warheads rendering small fractional-kiloton yields. TADM is a container compatible with low-yield warheads and the UFD. SADM is a special warfare device that weighs approximately 40 pounds and will give fractional-kiloton yields.

155mm Atomic Artillery Shell: This has a range up to 16,000 yards with a yield of 100 tons.

HAWK: This mobile surface-to-air guided missile system is being developed to fulfill the requirement for a weapon system capable of destroying targets at the lowest altitudes at which they can be expected. The system will be effective at altitudes from the horizon to above 45,000 feet, to ranges of 19 nautical miles for subsonic aircraft and to 13 nautical miles for supersonic aircraft. The system is scheduled to be operational in late 1959.

VIGILANTE: A light antiaircraft defense weapon system designed to provide protection to troops, facilities and installations in the forward combat areas. Two versions will be available: a lightly armored self-propelled model and an air-droppable towed model. VIGILANTE will be capable of engaging modern aircraft of speeds up to 800 miles per hour at ranges out to 4,500 yards and at altitudes up to 10,000 feet with an effectiveness of 50 percent hit probability during one-second engagement. The system can be operational in 1963.

~~SECRET~~

~~SECRET~~

MAULER: This is a concept rather than an actual weapon system and is visualized to replace the VIGILANTE. The objective of the program is to study and ultimately to develop a weapon system with an extreme high-level air defense capability against all types of enemy aircraft. This weapon is visualized as a highly mobile, self-propelled guided missile weapon.

Low-Endurance Drone Systems (Interim) (SD-2 and SD-3): These drones have photo or infrared capabilities, a speed of about 330 knots, an endurance of 45 minutes and a 100-pound payload. Test models are to be available in 1958.

<u>Unit</u>	<u>Item</u>
Company	AN/PPS-4
Battle group	AN/TPS-21
Division	AN/TPS-25

Intrusion-Detection Radars: To provide local security between occupied positions and surveillance to the front, these moving-target-indicating types of vantage-point radars will be useful for use at company, battle group and division.

High-Resolution Radar with Moving Target Indication: This radar is to extend area coverage of the MOHAWK radar to 100 miles, with a resolution of 20 feet or better. This new radar project is based on MICHIGAN beam sharpening and optical cross correlation techniques.

AN/VRC-12, PRC-25, PRC-35, and ARC-54: This is a new family of FM tactical radios. This program will provide improved communications within smaller units, battle group and below, and armored and artillery units, with anti-jam features. It includes vehicular, airborne pack and hand radio sets, each with 800 common channels.

AN/VRC-24: This is a forward air controlled radio providing UHF communications to supporting Tactical Air Command aircraft.

AN/GRC-65: This is a Division Command Net Radio, a jeep-mounted HF radio with a voice range of 50 miles. A modified version includes radio teletype with a range of 75 miles.

AN/MSG-4: The Missile Monitor is an air defense coordination system to provide a means, in the field army, of coordinating the fires of NIKE and HAWK fire units. It is designed to handle up to 16 fire units. Its purpose is to distribute the available firepower in an air defense area in the most effective way to meet the current threat. The system generates and/or collects data on the current air situation and distributes this information to the fire units automatically and continuously. It monitors the actions of individual fire units, overriding decisions of fire-unit commanders where necessary.

VT Fuze Jammer: Two of these jammers will provide protection coverage over a battle group front (AN/MLQ-8 (XE-2)).

~~SECRET~~

~~SECRET~~

Multi-purpose Jammer: This new project is to provide a mobile equipment with selective-type jamming over a frequency range from 2 to 15,000 megacycles.

Airborne ELINT: This new development is to provide an airborne ELINT system covering all the spectrum from 30 megacycles through K-band with automatic recording, time synchronization and direction finding.

~~SECRET~~

Page determined to be Unclassified
Reviewed Chief, RDD, WHS
IAW EO 13526, Section 3.5
Date: FEB 24 2011

~~SECRET~~

DECLASSIFIED IN FULL
Authority: EO 13526
Chief, Records & Declass Div, WHS
Date: FEB 24 2011

A RESEARCH PROGRAM FOR THE IMPROVEMENT OF
LIMITED WARFARE CAPABILITIES

Robert H. Shatz
Cornell Aeronautical Laboratory Inc.

Summary

This is an informal report, hurriedly prepared, for the Defense Science Board Task Group on Limited War. It contains a general summary of research projects performed and currently in progress at the Cornell Aeronautical Laboratory, Inc., Buffalo, New York. The areas covered include:

- Research and development on support weapons systems
- Air defense studies
- Tactical air studies
- Reconnaissance and surveillance studies
- Combat control system studies
- Combat area mobility

A brief list of recommendations for research and development is included.

This research has been sponsored by agencies of the Army, Navy and Air Force, and detailed reports for these projects can be obtained from the several project offices.

Recommendations for Research and Development

These recommendations are presented to assist the Defense Science Board Task Group on Limited War in establishing a program of research and development leading to improved military capabilities for U. S. forces which may be required to operate in limited nuclear or conventional warfare situations. The recommendations are the result of research performed during the past several years on many projects for the Armed Forces. Since this report was prepared very rapidly, the author will be pleased to explain these recommendations in more detail at the convenience of the Task Group.

~~SECRET~~

~~SECRET~~

(1) More emphasis is required on the development of small, very mobile surface-to-surface missile systems for use with conventional and nuclear warheads. These can be developed in the next five years and can take over many of the difficult close-support air operations if proper guidance schemes are developed.

(2) More concentration of research on field and overseas-based antiaircraft and antimissile weapons and warning systems is urgently required. Here development is not yet in sight, but research must be supported. Also, methods for hardening and defending U. S. overseas bases must be investigated, since many of these bases are vulnerable to ballistic missiles, which might be used by the enemy in certain limited-war situations. This is a problem whose solution is important to both the Air Force and the Army. It would be sensible to develop these overseas-based defense systems on some unified basis.

(3) More attention should be directed towards the development of our tactical air forces. It is clear that the U. S. Tactical Air Force needs more work on the improvement of unit mobility and better dispersal and passive defense planning.

(4) A VTOL attack aircraft weapon system would be of great value in both conventional and nuclear limited-war operations. Such a system, which could be really dispersed, protected and hard for the enemy to locate and kill, should be developed for tactical air operations.

(5) The Tactical Air Force needs to improve its reconnaissance capabilities. Many of the Cornell Aeronautical Laboratory studies showed that target location for the counterair mission is going to be very difficult.

(6) It is unlikely, in the next 10 years or so in limited warfare, that reconnaissance drone systems will completely replace manned aircraft, and so the Army's program in this area should be emphasized. This too needs research emphasis to improve and reduce the sizes of sensory and data-processing equipment and to develop means and organization for the rapid employment of information.

(7) The Army should plan to develop a VTOL replacement for the MOHAWK observation airplane. This will be a very useful vehicle for limited warfare, and a good design would probably also have some combat potential.

(8) The Navy should study the development of submarine-based reconnaissance systems to provide for the eventual development of a complete submarine task force.

(9) All three Services are developing combat control systems using automatic data-processing equipment. Many versions are needed for various limited-warfare tasks and these will be both complex and expensive.

~~SECRET~~

~~SECRET~~

The Department of Defense should look into the possibility of integrating these requirements to get equipments which the United States can afford and which will be compatible with technical and tactical requirements.

(10) Finally, in general, we must reconfigure our combat units and their logistics in order to make it possible to use them in the mobile warfare that any limited nuclear war will imply. If we do so--if we actually do develop the special units that can be airlifted, then we can build an air-transport system to deliver them to the combat areas and provide them with the special VTOL vehicles that they need for combat air-transport operations.

1. Introduction

This report has been prepared for the Defense Science Board Task Group on Limited War. It contains:

A brief statement of the probable limited war environment

Summaries of current projects at the Cornell Aeronautical Laboratory which contain information of value to the Task Group

Recommendations for research and development projects

The Cornell Aeronautical Laboratory (C.A.L.) is actively interested in improving our capabilities in limited warfare operations and will be pleased to help the Task Group in any way possible.⁴

Much of this material was presented to some of the members of the Task Group on December 11, 1957, when Mr. Robert H. Shatz and Mr. Harold A. Cheilek gave a presentation on this subject.

This subject is, of course, a nationally important problem which requires a much broader background than one research organization can provide. The Laboratory's background, however, has tended to emphasize limited rather than all-out war problems and technology. This background includes for example:

(1) A staff who worked on Project VISTA, which first tackled the questions of the use of nuclear weapons in support of ground operations

(2) Studies of tactical air operations conducted by C.A.L. in Project BUFFALO BILL, which ran from 1952 through 1956, and a series of

⁴Appendix A is a brief statement of the organizational character and current status of the Cornell Aeronautical Laboratory.

~~SECRET~~

~~SECRET~~

tactical air studies on weapons systems and their employment for The Air Force Director of Development Planning (AFDAP) and The Air Research and Development Command (ARDC).

(3) The development of a close-support missile system for the Army, the LACROSSE missile, now in production by the Martin Company,

(4) Studies of the problems of theater air defense and task force air defense in great detail for the Army, Air Force and Navy. This has even included a considerable (100 man years) effort on antimissile defense for the Field Army--C.A.L.'s Project PLATO. Air defense is one of the most difficult problems that will occur during the coming era of the potential use of nuclear weapons in limited warfare.

(5) Studies of a wide range of aeronautical problems including the field of VTOL and STOL (vertical and short take-off and landing).

Before going into detailed project summaries, it would be useful to summarize the current view of the expected environment for limited war, and the next section will cover this subject.

2. The Probable Environment of Limited War

The operational and environmental circumstances expected in the next ten years or so and the world-wide political situations which might occur impose upon the United States the following missions, which might be considered a part of limited-warfare operations:

Antiguerrilla operations

Support of our allies in suppression of a civil war

Stopping an invasion of allied territory by either satellite or Russian troops

The United States is politically committed to support a philosophy of measured deterrence.

The use of nuclear weapons in limited war may require preagreement or sanctuaries. Also, our military requirements will differ very markedly, depending upon whether or not overseas bases can be used. If they cannot be used because of the several reasons that arise in this connection, then task force operations from the U.S. will be necessary. In any case, future U.S. military requirements will include the need for both U.S.-based forces and overseas bases.

These problems, the weapons possessed by our potential enemies and the assumption of the need for either nuclear or conventional ordnance employment, generate our view of the expected combat environment. With the advent of tactical nuclear weapons and the increasing requirements

~~SECRET~~

~~SECRET~~

for high-capacity delivery systems, the rocket and the missile will become the general support weapons. The general pattern of ground warfare is moving in the direction of high mobility and quick decision. The availability of great firepower has made more important than ever the problem of quick and accurate target location.

Even in the case of the employment of conventional weapons, however, there is a need for an enhanced capability. Organizationally, U.S. forces should really be geared for tactical nuclear operations. Because of the nuclear threat, a combat posture adaptable to the sudden introduction of nuclear weapons must be assumed by both sides in a conflict. Russian technology has certainly not been at a standstill, and new weapons and new techniques in the hands of our potential enemies must be assumed. In this case, when conventional warheads are used, the importance of effective tactical air operations remains as high as ever before.

Let us consider one other aspect of the reaction to nuclear weapons: The existence of nuclear firepower forces the enemy to passive defense countermeasures. In defense the use of hardened and concealed targets may be expected to become more widespread.

Both in defense and attack there will be a disposition toward greater rapidity of movement and toward dispersal and greater utilization of terrain maskings, as well as toward movement at night or in bad weather. Again, all of this results in new requirements for target-location systems, for surveillance devices and for immediate firepower.

As indicated earlier, many of these considerations apply almost equally to the nonnuclear peripheral war. Indeed, Korea and Indo-China demonstrated the extent to which an enemy, in the face of an effective day-time air threat, can rely on night transport and night operations.

In summary, the characteristics of the future battlefield appear to be the following:

Military forces will be dispersed, and mobility will be of tremendous value.

Camouflage and deception will be primary operating tactics.

Major combat action or movement will take place at night and in bad weather.

Control of the air over the battlefield is of great importance.

There will be fewer strong points or fixed objectives, and the location of all combat elements will be much more transitory.

The battle area will be much larger than in the past, and large concentrations of men and materiel must be avoided.

~~SECRET~~

~~SECRET~~

Transport into the combat zone and combat-area mobility will be of great importance.

These characteristics will require a whole new set of tactical principles in order to handle the new weapons. The fundamental problem is to relate in the best way possible scientific and technical capabilities to this advanced view of the tactical problems.

Problem Areas

The discussion, therefore, highlights several important problem areas where research is needed to support our limited-war capabilities. These problem areas are:

Weapon systems that will give our forces either a nuclear or conventional punch. Clearly, guided missiles are better adapted for nuclear operations, and an effective Tactical Air Force is the hope for delivery of conventional ordnance.

Reconnaissance and combat control systems which can help make up our intelligence deficiencies and allow U.S. forces to act with rapidity and decision in this difficult environment.

The provision of improved vehicles and techniques for combat-area mobility and the need for new logistic concepts to speed battle operations and supply our forces under really difficult circumstances.

3. Summary of the C.A.L. Program

This section lists the C.A.L. projects that are pertinent to the objectives of the Task Group on Limited War. Operations analyses, weapon system evaluations and the study of weapon system requirements have been important activities of the Cornell Aeronautical Laboratory. Studies in these areas have been performed both as part of the planning and preliminary design phase of specific weapon development programs of the Laboratory and in direct support of research and development planning activities of agencies of the Department of Defense.

Operations analyses, vulnerability studies and cost-effectiveness studies play an important role in the conversion of generalized military requirements into desired characteristics for defense systems. For example, the selection of an optimum warhead for a missile involves an understanding of numerous exchanges such as warhead weight versus missile gross weight and associated logistics and costs. The selection of missile range requires an examination of probable deployment, organization and tactics, and these considerations in turn require an analysis of such factors as coverage versus logistic support.

The projects outlined in this section include examples of all of the types of these studies. Whenever possible, conclusions are summarized.

~~SECRET~~

~~SECRET~~

However, because much of this is part of research now under way, these conclusions should be viewed more as a report of progress rather than a final statement. The projects are listed under the following general subject headings:

- Research and development on support weapons systems
- Air defense studies
- Tactical air studies
- Reconnaissance and surveillance studies
- Combat control system studies
- Combat area mobility.

3.1 Research and Development on Support Weapons Systems.

3.1.1 Project LACROSSE, Contract No. DA-30-115-ORD-47: As a result of World War II experiences, particularly in certain Pacific campaigns, the Armed Services recognized an urgent need for a close-support weapon of high mobility, all-weather capability, low cost and high reliability and ruggedness. LACROSSE is a surface-to-surface guided missile system fulfilling the need for a close-support weapon for ground troops. Among the system components are specially designed radar tracking and ranging equipment, a guidance computer, an optical target survey unit and a missile launcher. Current plans include both conventional and atomic war-heads for the system.

Initial effort on LACROSSE began in 1947 with a feasibility study in collaboration with the Applied Physics Laboratory of The Johns Hopkins University. A research and development contract followed two years later, Cornell Aeronautical Laboratory, Inc. acting as prime contractor. Upon successful range demonstration of LACROSSE's capability, the C.A.L. helped the Army to select a production contractor and now is assisting the Ordnance Corps in monitoring the production contract. Many studies of costs and military utility have been made for the Army on LACROSSE. Figures 1 through 3 show some of the details of this system.

3.1.2 Project ABC, Contract DA-30-115-ORD-47: Under the LACROSSE Airborne Controller program, the concept of LACROSSE forward guidance is being extended to include guidance stations operated from Army aircraft. In such a system the aircraft position relative to the launching site must be known within 15 to 20 meters. An immediate solution involves the use of radar-tracking and FM - CW (frequency modulation - continuous wave) distance-measuring equipment, which are available from the present LACROSSE system with relatively minor modifications. An advanced solution also under development will use an all-inertial navigation system. The techniques and components developed in this project should be applicable to other guided missile weapons as well as to reconnaissance drone systems.

Figures 4 through 7 show some of the capabilities and provide block diagrams of the several modes of the ABC System.

~~SECRET~~

~~SECRET~~

DECLASSIFIED IN FULL
Authority: EO 13526
Chief, Records & Declass Div, WHS
Date: FEB 24 2011

3.1.3 Advanced Close-Support Guided Missiles Studies, Contract DA-30-115-ORD-908: At the request of Redstone Arsenal (Department of the Army), the Cornell Aeronautical Laboratory, Inc. is conducting feasibility studies of several types of advanced guided missile divisional general support artillery weapons. These weapons are to be more mobile and air-transportable than current artillery and support missile systems. Systems are being evolved using guided missile techniques to solve the specified military problems.

Figure 8 is an example of one of these weapons. These short-range missile weapons are being studied in the context of limited-war operations for the employment of both nuclear and conventional warheads.

3.1.4 Conclusions--Weapons Development: The C.A.L. believes it quite possible to build very effective and truly mobile surface-to-surface missile weapon systems which can be used with either conventional or nuclear warheads if the correct type of guidance is used. We think that forward control and guidance, either ground or airborne, will prove very useful. This is, however, now only in a very early stage of research, since many actual technical problems have not been resolved and as yet our Military Services have not specified any firm requirements--and probably won't unless additional funds are provided. These missiles, if properly conceived, can be used in a great many limited-war situations, but they must be designed to go into the field without a mammoth supply train. This means that they must achieve a high level of reliability and simplicity and be secure from countermeasures of all sorts, ours as well as the enemy's.

3.2 Air Defense Studies.

3.2.1 Project PLATO Antimissile System Study, Contract No. DA-30-115-ORD-543: Under Army sponsorship, the C.A.L. synthesized a guided missile system for the defense of ground installations against attack by ballistic missiles and aircraft. Detailed and novel designs were carried out for acquisition and tracking radars, tactical control equipment and communication equipment. The practicability of solving certain critical problem areas in the system design was demonstrated. The complex target to be defeated, the technical state of the art to be applied, and the possible tactics of use--all had to be compatible with the time at which it could be expected that a new system would be available. A lethality and vulnerability study established accuracy and performance requirements. Evaluation studies established the worth of this system in relation to the defended area and to the enemy weapon. The expenditure in cost, logistics and manpower to realize such a defense capability was assessed. Studies were made of NATO theater defenses, overseas base defense and defense in the zone of the interior.

3.2.2 Project TAFAD, Contract No. NOa(S)-56-704-c: Project TAFAD, conducted for the Bureau of Aeronautics, was a study to determine the

~~SECRET~~

~~SECRET~~

DECLASSIFIED IN FULL
Authority: EO 13526
Chief, Records & Declass Div, WHS
Date: FEB 24 2011

best means of defending the naval task group's perimeter by using piloted fighters in the 1962 - 1967 period. It was assumed that the inner defense will be maintained by surface-to-air missiles.

Definitions of potential weapons systems were established and evaluated by C.A.L. The project selected a final system and developed a preliminary specification suitable for the initiation of a system development program.

3.2.3 Project FLAME, Contract No. Nonr 2220(00): Project FLAME is a continuing study of fleet antimissile defense problems in the period 1960 - 1970. The study is divided into two phases: (1) the determination of the missile threat to the naval task force and (2) the derivation and evaluation of a suitable antimissile defense system to counter the threat.

The threat study concludes that the most severe and likely threat is from short-range (maximum range of 150 nautical miles), submarine-based ballistic missiles. The second most severe and likely threat is from high-speed (Mach 5) air-to-surface missiles (ASM) delivered from ranges up to an approximate maximum of 300 nautical miles. Although land-based ballistic missiles are considered a technical threat, these missiles are not considered a tactical threat at significant ranges (greater than 750 nautical miles) owing to the difficulty of attaining the high level of system development, reliability and efficiency required.

The derivation of a suitable antimissile defense system to counter these threats is currently in progress. Parametric studies have been completed describing the variation of three major parameters in the fleet antimissile defense problem. These are (1) the ranges at which the ballistic-missile threat is detected, (2) the average speed of the defensive missile and (3) the response time of the defense system. Based on the results of the parametric studies, requirements have been established for task force antimissile defense systems for various possible threat spectrums. The currently planned advanced TALOS missile system has been evaluated in the light of the foregoing requirements. At present, a defense system design concept is being evolved and a preliminary feasibility study of the system is in progress.

3.2.4 Project ADTAC (Air Defense of Tactical Air Command), (AFDAP), Contract No. AF 18(600)-398: The Cornell Aeronautical Laboratory has studied the general problem of mobile tactical strike force operations deployed from the United States in a limited nuclear war. Specifically, we looked at the feasibility of a mobile active air defense for an advanced tactical air base in the middle eastern area. The study was restricted to the feasibility of using an active air defense for a mobile strike force. The problem as analyzed was investigated by varying the different parameters in the organization and deployment of the mobile strike force: the type and composition of the defense and the altitude, size and speed of the attacking forces, cost, mobility, air transportability, and system setup times were of primary concern.

~~SECRET~~

~~SECRET~~

DECLASSIFIED IN FULL
Authority: EO 13526
Chief, Records & Declass Div, WHS
Date: FEB 24 2011

The conclusions were as follows:

- (1) The air defense of an advanced base against an aircraft threat is best achieved by a surface-to-air missile defense system, since the conventional fighter systems cannot provide an adequate defense.
- (2) In general, active air defense of an advanced base is very costly.
- (3) Active air defense of hardened advanced bases against ballistic missiles appears technically possible but very costly.

3.2.5 Project ADTAC II (AFDAP), Contract No. AF 49(638)-96: The C.A.L. is now studying the requirements for a tactical area air defense system for the operational time period 1963 - 1968. Specifically, this investigation is concerned with determining the proper balance or trade-offs between active and passive air defenses for the Tactical Air Forces (TAF) in Europe.

Active air defense measures considered are missiles, anti-aircraft guns and interceptors. The passive defense measures include dispersal, mobility, camouflage, early warning, electronic countermeasures (ECM) and protective shelters.

At present, the basic framework of this study has been completed and the study group is finishing an analysis and evaluation of the quantitative results of the model campaigns. It is believed that the results of the study will contribute towards the development of a new and more effective military posture for the Tactical Air Force, in that it will demonstrate the requirements for improved passive defenses which will tend to reduce the load on the active defense systems.

3.2.6 General Conclusions on Air Defense Problems: As a result of these air defense studies for the Army, Navy and Air Force, the C.A.L. believes that U. S. military forces face very serious problems in any warfare situation in which the enemy uses missiles and nuclear weapons. None of the current U.S. air defense weapons systems are really mobile in a field employment sense. Also, we now have to add antimissile requirements both to the base defense schemes and to our field units, and this is going to be very difficult and expensive since no really good system yet exists that will detect the missile-carried decoy. Yet the premium for this is so high, i.e., the survival of our overseas bases and field units may depend on the efficiency of early warning radar and active defense, that the U.S. program must include serious work along this line. Here is an area in which research should be supported for many types of weapons systems, but thus far only the continental defense against missiles is receiving any attention. It is unlikely that this work will result in either base defenses or really mobile field systems. New approaches and more research work are needed. Perhaps viewing the problem in terms of the defense-hardened and concealed targets will ease the problems. This

~~SECRET~~

~~SECRET~~

DECLASSIFIED IN FULL
Authority: EO 13526
Chief, Records & Declass Div, WHS
Date: FEB 24 2011

is at least worth studying. It is hard to overemphasize the need for this work since the United States will soon be pressed by our allies for some assurance that effective antimissile defenses will be provided to them.

3.3 Tactical Air Studies.

The projects mentioned in this section are part of a continuing program of research performed for the Air Research and Development Command and the Air Force Office of the Director for Development Planning during the past three years. They include weapons systems studies, NATO theater studies, and a study of mobile air task force operations.

3.3.1 Project ARM-VAL (ARDC), Contract No. AF 18(600)-1550: Project ARM-VAL was a study of offensive air-to-ground weapons systems as used by the Tactical Air Forces. Its purpose was to provide data to assist the ARDC in research and development planning for air-to-ground weapons systems. The investigations, conducted in the fields of both conventional and nuclear warheads, were concerned with typical targets, weapon lethality, accuracy requirements, weapon delivery and launching methods, and survival tactics.

3.3.2 Project MACAW (AFDAP), Contract AF 18(600)-398: Project MACAW investigated tactical air operations in the NATO theater context for the time period 1963 - 1968. It was based on the assumption of less than all-out nuclear war--meaning that only military targets were attacked with limited yields sufficient to neutralize the targets. The project's objective was to evaluate Tactical Air Command (TAC) missiles and aircraft weapons systems and their tactical deployment. We looked at cruise and ballistic missiles and VTOL and conventional aircraft in a variety of simulated campaigns. Consideration was given to various degrees of dispersal, base hardening and unit mobility.

In general, our results showed that tactical missile and aircraft organizations should be designed for as high a degree of dispersal and mobility as is economically possible. This is difficult to accomplish with ballistic missiles because of their special problems, and here base hardening will be necessary. Also we found that the VTOL attack aircraft will provide the TAC excellent strike mobility and flexibility.

3.3.3 Project TAWS (ARDC), Contract No. AF 18(600)-1669: Project TAWS is a tactical air weapons study for ARDC with the objective of evaluating the Tactical Air Force ability to survive an initial attack in the theater through such measures as dispersal, hardening and mobility consistent with the established combat posture and the projected technical capability from the present to 1970. The study also includes comparisons of ECM and other countermeasures to defeat or degrade various air defense networks and an evaluation of nonnuclear ordnance delivery, including conventional and BW - CW (biological - chemical warfare), by tactical air systems designed primarily for the delivery of nuclear weapons.

~~SECRET~~

~~SECRET~~

DECLASSIFIED IN FULL
Authority: EO 13526
Chief, Records & Declass Div, WHS
Date:

FEB 24 2011

The initial phase of the study examined the following question: How can the presently planned Tactical Air Force survive and maintain a combat posture within the NATO theater against a nuclear attack? The time period considered was up to 1962 and the factors investigated relate directly to such operational concepts as:

- (1) Compatibility and tactical utility of zero-launch schemes with dispersal and hardening plans
- (2) Adequacy of theater and local early warning and command and control networks

The final phase will consider the introduction of new weapons and operational concepts which might apply in the post-1962 period. Air Force augmentation from other areas and the effect of intratheater logistics for redeployment in a rapidly changing base complex will also be considered. The definition of means for achieving a greater degree of mobility than is now available will be a primary objective of the study. New operational concepts will be evaluated by means of campaign models. The project will be completed in a year.

3.4 Reconnaissance and Surveillance Studies.

A discussion of this area is particularly appropriate in considering limited-war research and development requirements, since in many areas of the world--and certainly in many limited-war situations--U.S. forces will start with an initial intelligence disadvantage which must somehow be overcome. Also, all of the current military concepts based on high mobility, increased firepower, and rocket and guided missile delivery systems require for their use improved and rapidly available information to permit commanders to make timely decisions. Finally, it is apparent that any war involving nuclear weapons will force both sides to dispersal, concealment and night operations, and all of these demand the development of better sources of information and better techniques for their use.

The Cornell Aeronautical Laboratory staff is very interested in all aspects of this area of research and thinks that solutions to many of the problems are in sight. Currently the Laboratory is working on several projects for the Army and is studying others using Laboratory funds.

3.4.1 Project RADS, Contract No. DA-36-039-SC-74910: The Army is making a broad attack on the development of reconnaissance systems for both drone and manned aircraft. The Signal Corps is directing this work, which includes:

- (1) Interim drone-system developments under Ft. Huachuca and the development of an electronic system for the MOHAWK observation airplane
- (2) Two new drone-system development projects and a systems requirements study project under Ft. Monmouth

~~SECRET~~

~~SECRET~~

The C.A.L. is conducting the systems requirements study and is developing an analysis of the tactical and technical requirements for reconnaissance drone systems and for the MOHAWK and an assessment of the feasibility and applicability of existing and proposed systems and components. The Laboratory will also assess the relative value of the drones and the manned systems. This is a two-year project; the Laboratory has been working for about six months. The operational studies include target conditions expected in limited- and general-war situations.

3.4.2 Army Combat Surveillance Project, Contract No. DA-36-039-SC-74980: The C.A.L. has established a Washington office and a study group for a two-year investigation to assist the Army's Combat Surveillance Agency in the establishment of general reconnaissance and surveillance research and development requirements. Limited- and general-warfare operations throughout the world will be considered. The group started work in January 1958.

The basic problem on which this group will work is that of enhancing the effectiveness of future Army operations by improving the combat capability for providing commanders at each echelon with fast and accurate data on the battlefield situation, sufficient to provide the basis for timely and effective tactical plans and decisions.

Intensive study is needed to determine the precise nature of necessary battlefield intelligence data, and the answers to such questions as "Who needs the data?" "How often must it be updated?" and "How long must it be stored?" Potential data sources must be evaluated and compared, not only in terms of their ability to collect raw data but also in terms of the amount of processing involved and the time consumed in extracting useful information from the raw data and how such information can complement other information sources in producing evaluated intelligence. Clearly, an important study area is concerned with the problem of evaluating the quality of input data and the development of methods for integrating good and poor qualities of information. This establishes the following objectives for the proposed program:

(1) Determination of the surveillance requirements of the Army for the periods:

1957 - 1960
1960 - 1965
1965 - 1970

(2) Synthesis and evaluation of a system (or interlocking systems such as a surveillance system and an intelligence system) appropriate to the requirements for each time period

(3) Identification of redundancies and inconsistencies in the present R&D program, and the identification of new R&D problems

~~SECRET~~

~~SECRET~~

3.4.3 Submarine-Based Reconnaissance System, C.A.L.-Sponsored Research: The C.A.L. has made a study of naval reconnaissance problems and has proposed to the Navy the development of a submarine-based system for use in both pre-D-day and limited-war operations in support of ship and submarine operations. This is a plan which would have great value in support of naval task force operations in such difficult areas as the Indian Ocean in which the U.S. would be trying not to expose its intentions or the surface task forces to nuclear attack.

3.5 Combat Control Systems Research.

3.5.1 Army Study, C.A.L.-Sponsored Research: The C.A.L. has studied the problem of providing a combat command system for field army operations that would provide commanders of combat units with timely intelligence of sufficient scope and detail to permit them to continually monitor their own and the enemy's status. This system would take all intelligence, logistic and tactical data, process it by means of a machine-aided intelligence staff, and produce displays from which combat decisions can be made. This is the type of system which, to be of any use, must be mobile, air-transportable and designed to make full use of modular construction and advanced techniques; in this way it can be used in chunks as necessary at different organizational levels in a wide variety of combat situations. Nuclear missile operations force the U.S. to this complex development if our forces are to get precise data for weapon selection and fire control.

3.5.2 Project NTDS, Contract No. NObsr-72628: The C.A.L. is also doing a similar study of the Naval Tactical Data System (NTDS) which is to be used for the control of task force operations. This study includes an investigation of the air defense and offense requirements of the NTDS and the development of data load and control programs for the central computer of the NTDS.

3.5.3 General Conclusion on Combat Control Systems Research: The Department of Defense should eventually recognize the need to integrate the requirements for all of these data-processing systems, including those of the Air Force, to make it possible for them to communicate rapidly without too many translator equipments in some common machine language and to limit the use of the microwave spectrum. More basically, since all of these systems are very expensive, inter-Service requirements should be established to take maximum advantage of production techniques and to standardize the final equipments.

3.6 Combat Area Mobility.

3.6.1 Project MAT, Contract No. FY57-266-9: The C.A.L. is working on an Army-supported study designed to explore the role of air transport in field support of the mobile army. There should be a real pay-off in this area if intelligent compromises between unit size and weapons and aircraft technology can be developed.

~~SECRET~~

~~SECRET~~

Considerable attention has been given the question of the technical developments that are needed to produce air transports (STOL and VTOL) whose take-off and landing accommodations are sufficiently modest that they might be used to support the mobile army in the field. However, it is not apparent that commensurate effort has been made to assess quantitatively the role of air transport in field support of the mobile army--explore how it would perform the support functions, considering support requirements, missions and organization and design feasibility; compare its performance with that of competitive transport forms; and, for those functions where distinct military advantage is shown to result from its use, define the required military characteristics of the aircraft.

The Laboratory understands that studies have been made of the logistics and economics of air supply from the zone of the interior to intermediate bases, and we are focusing this study on the questions inherent in battle-field movement and supply.

Our investigations consider the support of the "new" highly mobile army. Thus a premium will be placed on the ability to shift offensive and defensive positions and to supply the troops at these positions rapidly and at the appropriate times. Under these conditions, we'll try to find out whether air transport actually offers significant advantages over surface transportation in timely, rapid troop and materiel movement.

The first problem in such a study is to determine the classification and quantities of troops and materiel to be moved, the distances involved, the desired schedules and the topographies of the positions likely to be selected. The answers to this form a rough base for estimating aircraft fleet size, composition and characteristics.

In assessing field requirements, one must consider the ability of the aircraft to move the combat units and their supplies at the militarily appropriate time (even though it involves darkness and bad flying weather), the attrition to combat unit effectiveness resulting from aircraft vulnerability to enemy action and natural hazards, and the organization needed to support the aircraft fleet.

One must also face the problem of how local intraposition movements will be accomplished--whether helicopters and flying cranes can handle the bulk of this movement and what air-carried surface transport must be included.

The interrelationships among supply rates, inventory and depot requirements, and aircraft fleet composition and characteristics should be examined.

Studies such as these (which set aircraft and organizational requirements), combined with feasibility studies (which draw from the results of many current and projected aircraft design investigations), will lead to

~~SECRET~~

~~SECRET~~

DECLASSIFIED IN FULL
Authority: EO 13526
Chief, Records & Declass Div, WHS
Date: FEB 24 2011

a definition of an air transport system for battlefield movement and supply together with quantitative estimates of its effectiveness and cost. Then a comparative evaluation of air transport and surface transport of combined modes can be made.

Although the group has been working only three months on a two-year project, a few tentative conclusions can be mentioned:

It is clear that, to get any really effective combat area mobility, to really use to maximum extent the full potential of aeronautical technology, we must redesign our military units. We must have smaller, more austere units, fewer but more effective weapons and equipment. Only units that fight with nuclear weapons can make the maximum end use of these concepts. However, if we do as stated, we can have small, highly mobile units which can be air-delivered to any theater of operations very rapidly and which can be used to back up the more conventional forces of our allies. Also, such special units can be the most likely survivors--and thus the winners--in a limited nuclear war. Certainly this concept should be developed in great detail.

~~SECRET~~

~~CONFIDENTIAL~~

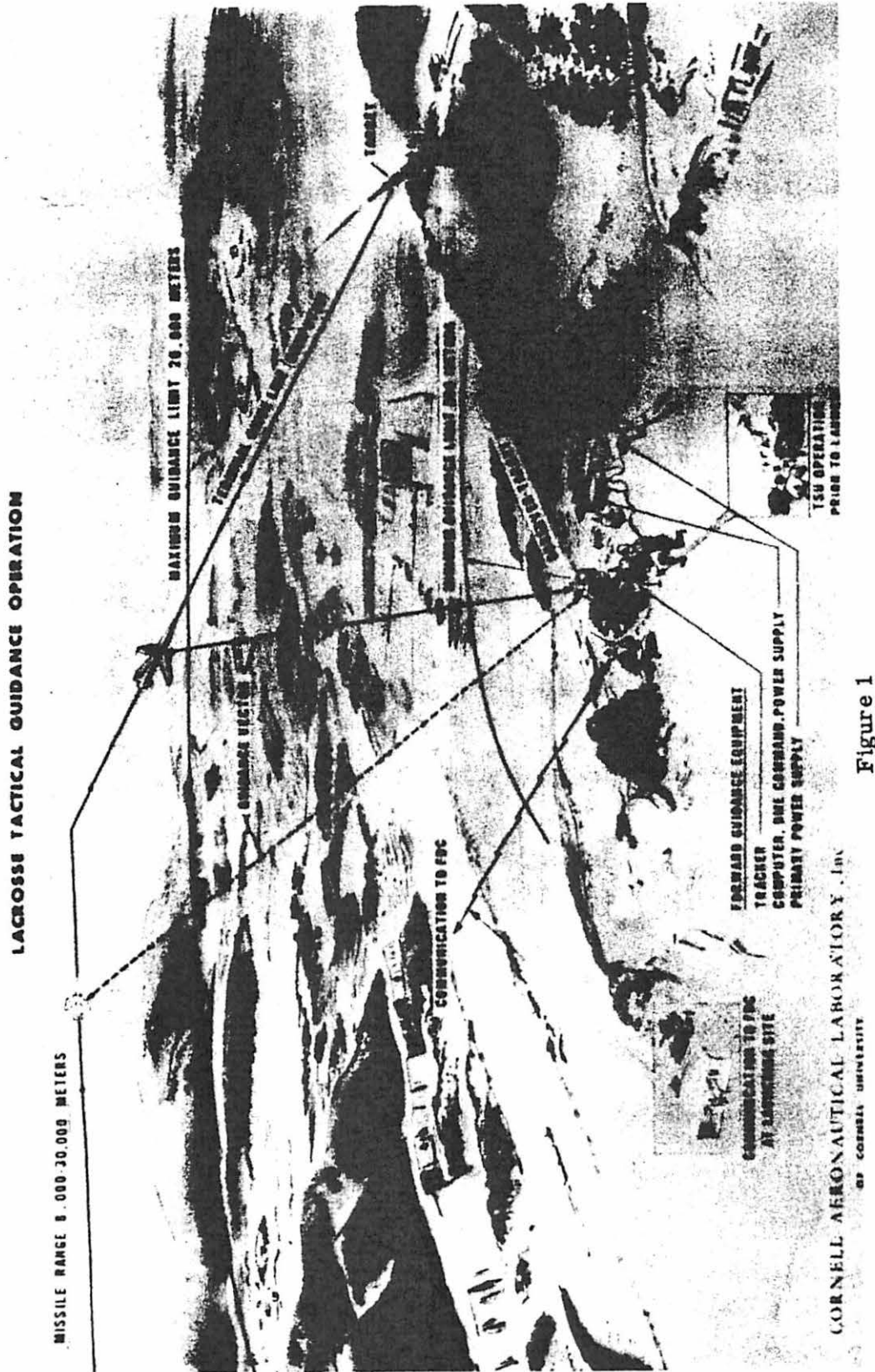

~~CONFIDENTIAL~~

CONFIDENTIAL

42

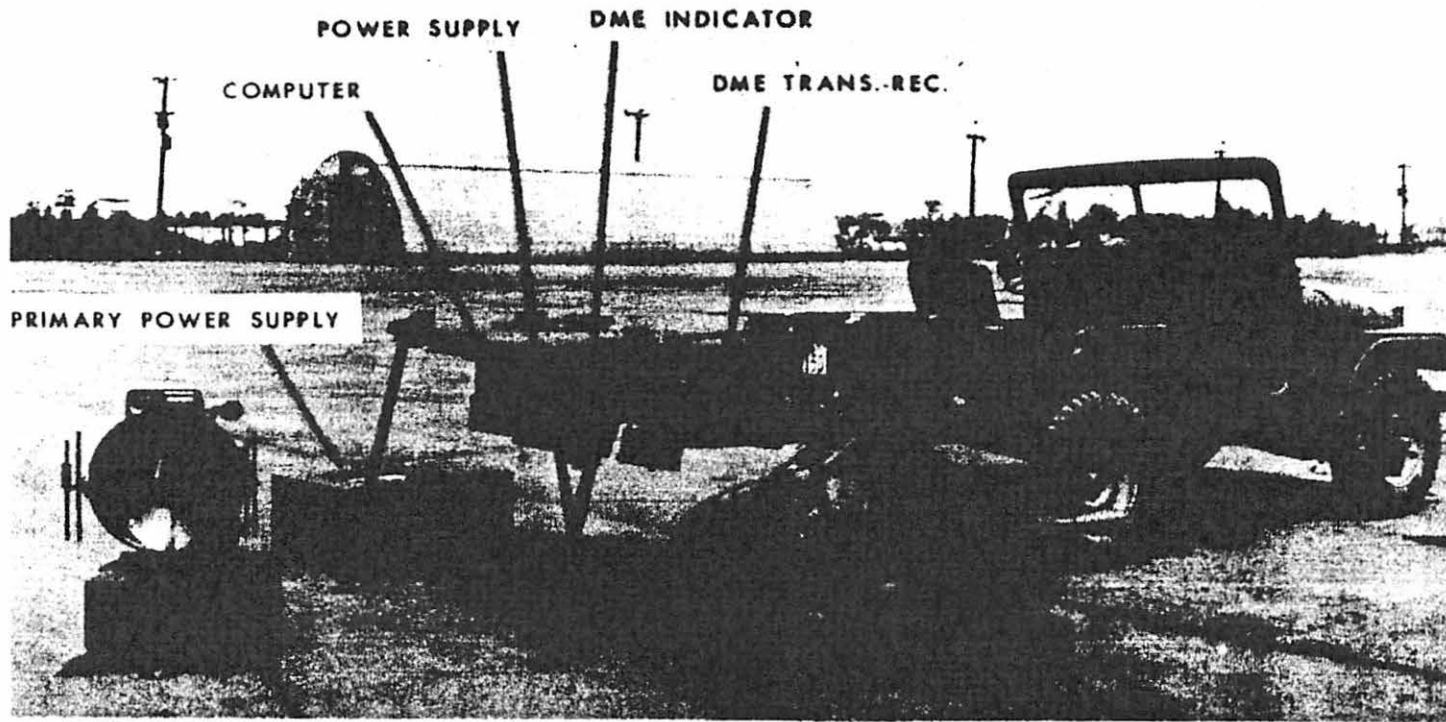

ANGULAR TRACKER

TARGET SURVEY UNIT

Lacrosse Forward Guidance Station Group B

Figure 2

CONFIDENTIAL

DECLASSIFIED IN FULL
Authority: E.O. 13526
Chief, Records & Declass Div, WHS
Date: FEB 24 2011

~~CONFIDENTIAL~~

DECLASSIFIED IN FULL
Authority: EO 13526
Chief, Records & Declass Div, WHS
Date: FEB 24 2011

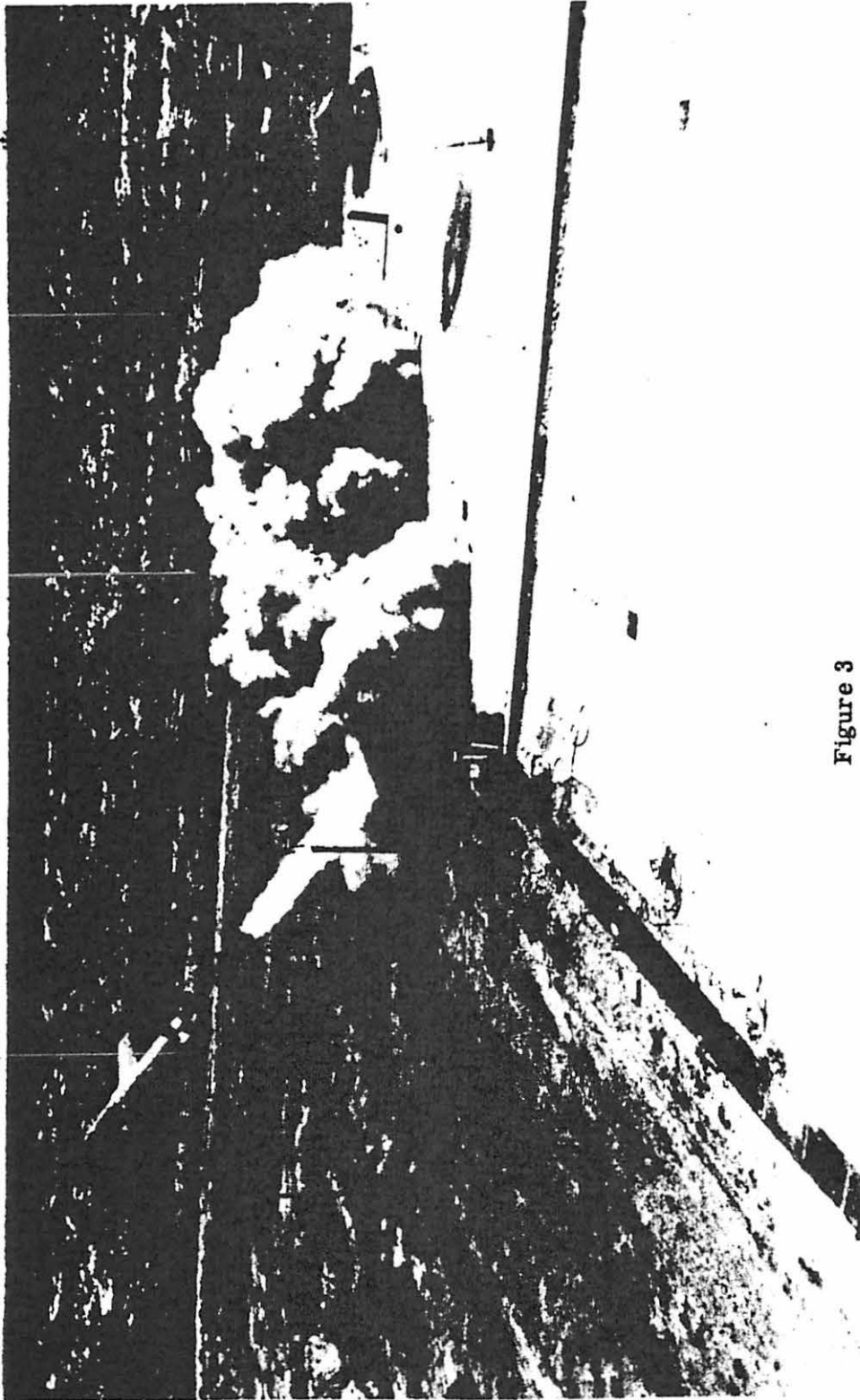

Figure 3

Lacrosse Group A Missile SN 16 Firing

~~CONFIDENTIAL~~

~~CONFIDENTIAL~~

DECLASSIFIED IN FULL
Authority: EO 13526
Chief, Records & Declass Div, WHS
Date: FEB 24 2011

AIRBORNE CONTROL SYSTEM CAPABILITIES

1. LINE OF SIGHT GUIDANCE OF LACROSSE MISSILES,
HIGH ACCURACY
2. AIRBORNE GUIDANCE OF LACROSSE ATOMIC MISSILES
USING INERTIAL NAVIGATION
3. ACCURATE TARGET LOCATION, RADAR TRANSFER TO
LACROSSE FGS.
4. TARGET LOCATION AND INERTIAL TRANSLATION
WITH JAMMING SECURITY, ATOMIC WARHEAD ACCURACY

Figure 4

~~CONFIDENTIAL~~

AIRBORNE CONTROL SYSTEM BLOCK DIAGRAM

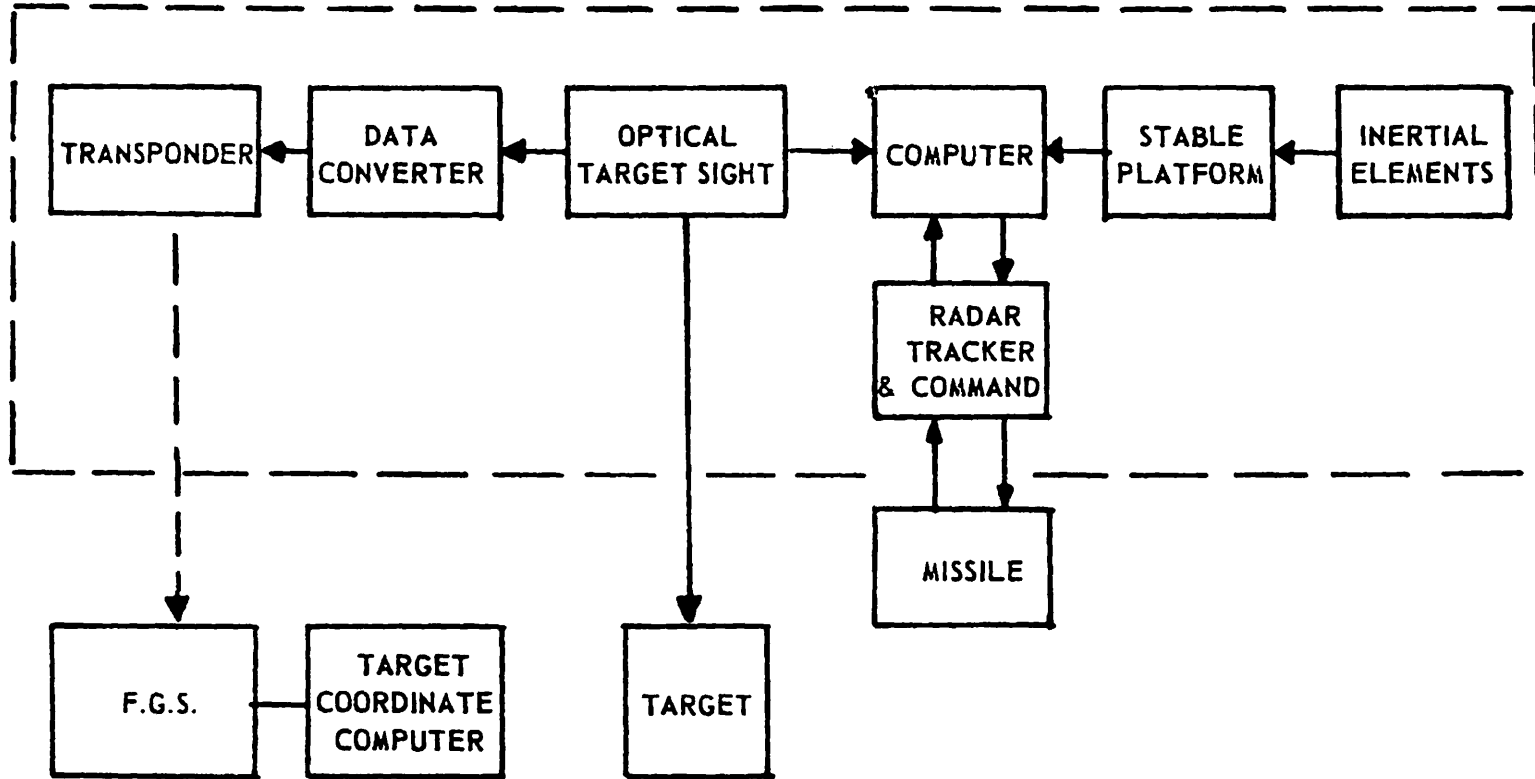

Figure 5

~~CONFIDENTIAL~~

45

~~CONFIDENTIAL~~

DECLASSIFIED IN FULL
Authority: E.O. 13526
Chief, Records & Declass Div, WHS
Date: FEB 24 2011

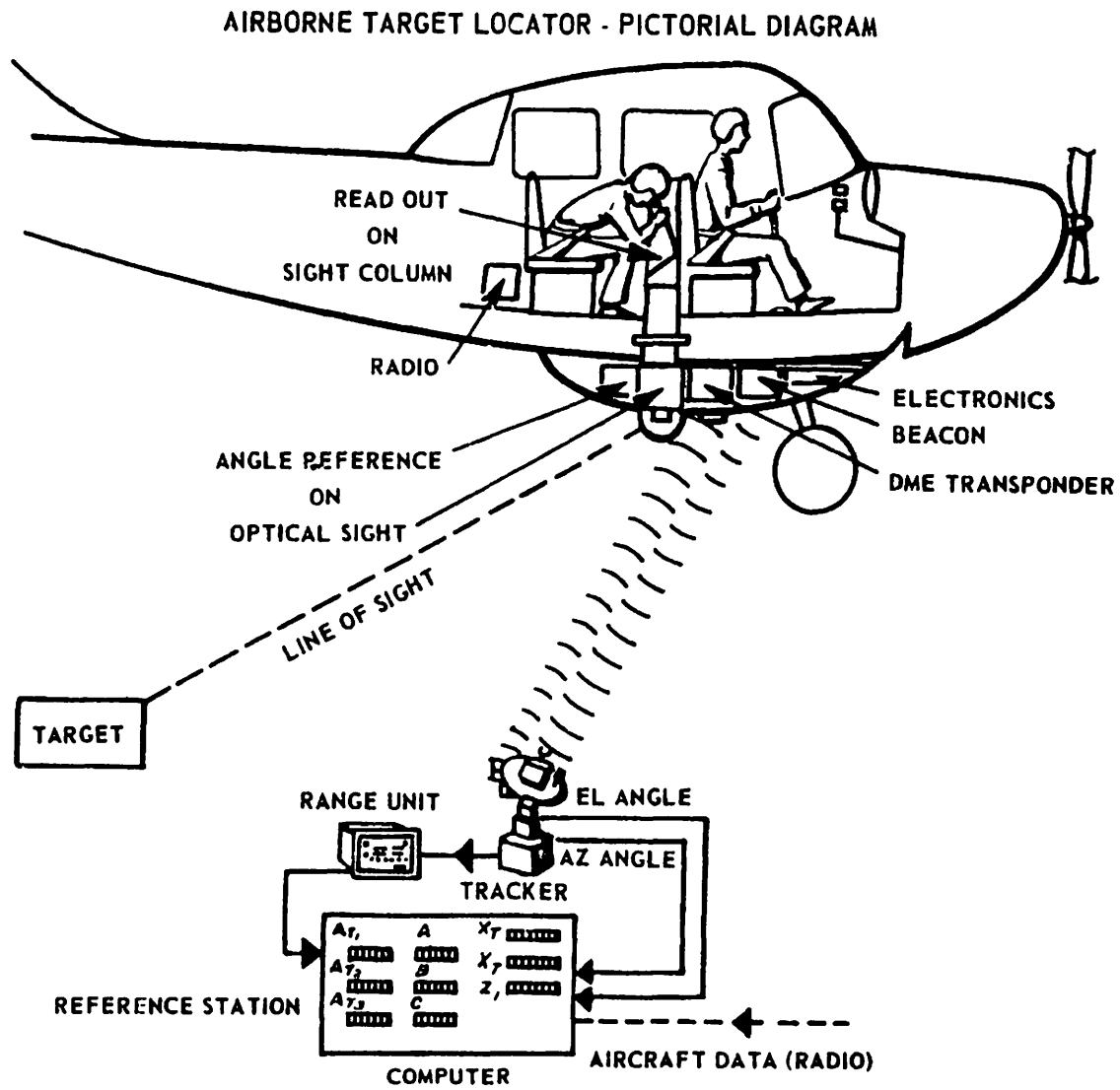

Figure 6

~~SECRET~~

47

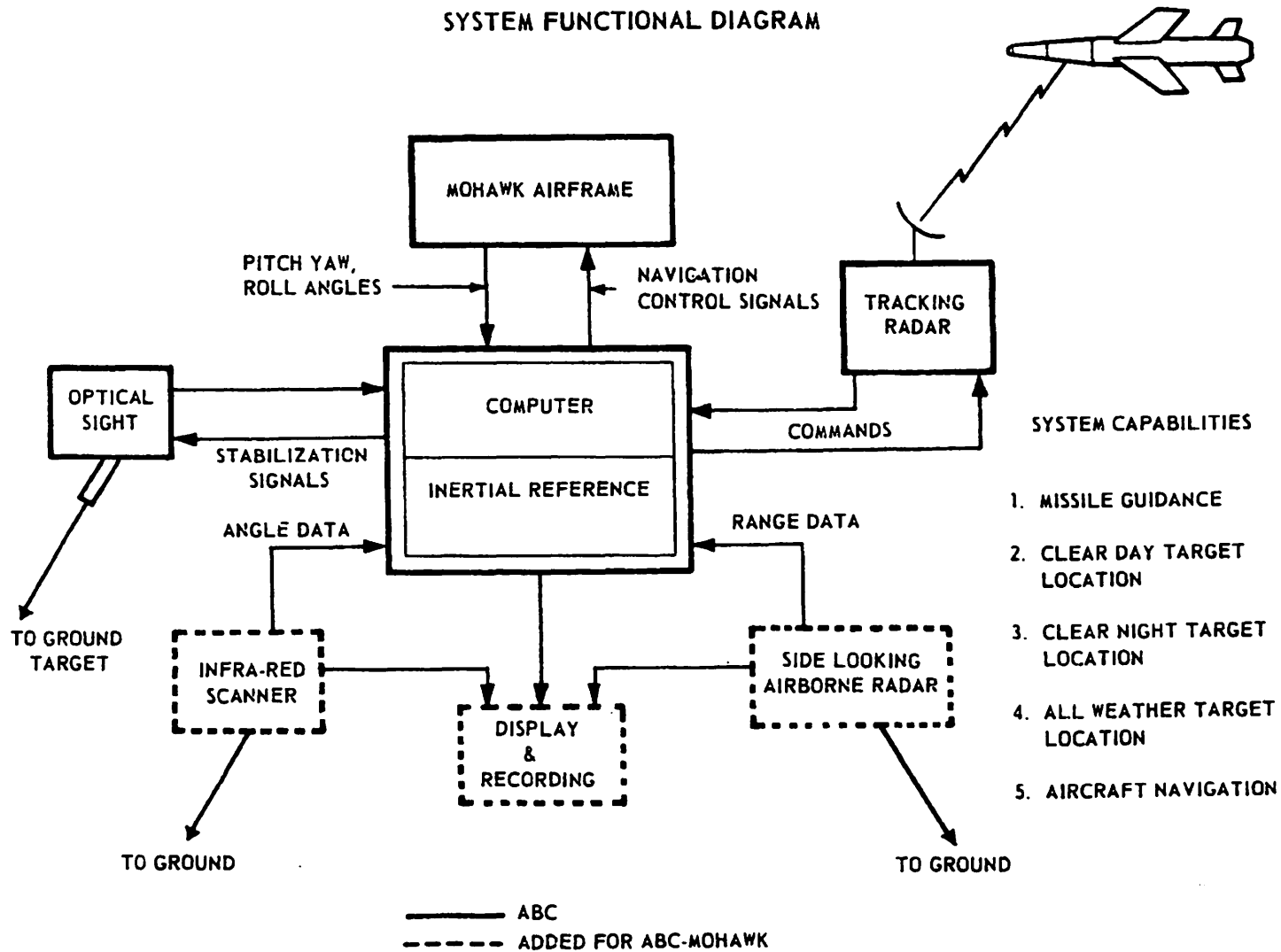
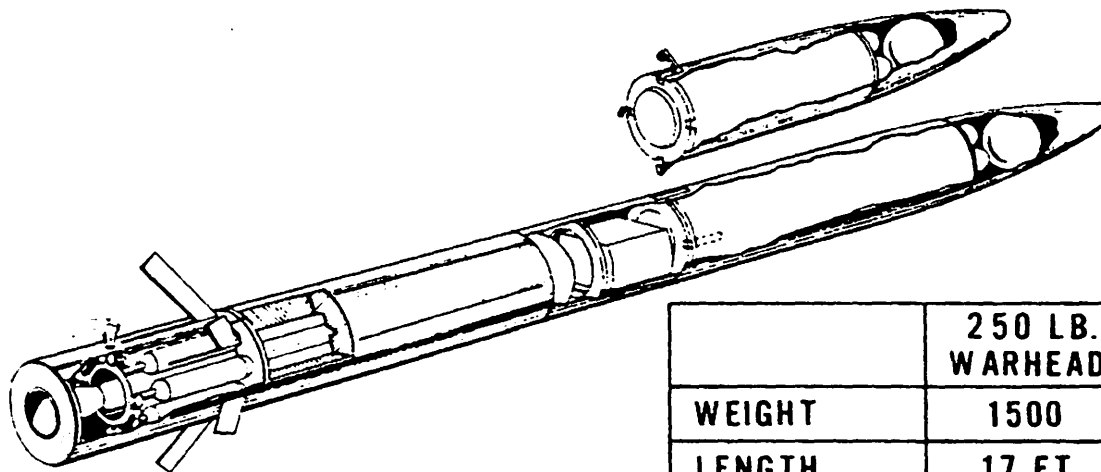

Figure 7

~~SECRET~~

DECLASSIFIED IN FULL
Authority: EO 13526
Chief, Records & Declass Div, WHS
Date: FEB 24 2011

BOXER MISSILE CHARACTERISTICS



	250 LB. WARHEAD	500 LB. WARHEAD
WEIGHT	1500	1750
LENGTH	17 FT.	18 FT.
DIAMETER	16 IN.	
IMPULSE	160,000 LB. SEC.	
FLIGHT TIME	3 MIN.	2 MIN.
RANGE	40 N. M.	25 N. M.
MACH NO. MAX.	3.5	2.9

Figure 8

~~SECRET~~

48

~~SECRET~~

DECLASSIFIED IN FULL
 Authority: EO 13526
 Chief, Records & Declass Div, WHS
 Date: FEB 24 2011

~~SECRET~~

DECLASSIFIED IN FULL
Authority: EO 13526
Chief, Records & Declass Div, WHS
Date: FEB 24 2011

APPENDIX A

The Cornell Aeronautical Laboratory, Inc.

The Cornell Aeronautical Laboratory, Inc., began operation on 1 January 1946 as a nonprofit organization under the Cornell Research Foundation, Inc., and in 1948 was incorporated as a wholly owned subsidiary of Cornell University. Having a self-sustaining business operation, the Laboratory is financially independent of the University. By virtue of University representation on the Laboratory board of directors and the fact that the President of the Laboratory is also the Vice-President of Cornell University, a close link is formed between the University and the Laboratory with respect to broad policy decisions. The Executive Vice-President of the Laboratory, as its Director, manages all of its operations through a group of 15 technical departments and supporting business and administrative departments.

The Laboratory's purpose is to be "an instrument of service to the aircraft industry, to education, and to the public at large." To fulfill this purpose, it has developed talents in applied research which bridge the gap between fundamental knowledge gleaned from pure research and the end products wrought from development. To maximize the usefulness of its research programs and to advance its own technical knowledge and resourcefulness, it is quite natural and necessary for the Laboratory to coordinate its programs closely with industrial concerns so that they may refine the Laboratory's development models and techniques for production and so that the Laboratory's personnel will be free to attack new technical problems. Illustrative of this coordination philosophy are the complete LACROSSE weapon systems designed and developed at Cornell Aeronautical Laboratory and turned over to the Martin Company for manufacture. The Laboratory's programs range from multimillion-dollar endeavors requiring project organization extending into several departments to small study programs requiring a single man. With various technical disciplines categorized into independent technical departments and with intentional flexibility in program organization, large and small projects are easily accommodated by the Laboratory.

The Laboratory's facilities for research include a transonic wind tunnel, supersonic tunnels, hypersonic shock tubes, altitude chambers, static test machines for structures (hot or cold), radars, analog and digital computers and complete shop facilities for fabrication of experimental models and equipment. In addition, complete laboratories are

~~SECRET~~

~~SECRET~~

DECLASSIFIED IN FULL
Authority: EO 13526
Chief, Records & Declass Div, WHS
Date: FEB 24 2011

available for electronic, physical and chemical testing. Its proximity to the Buffalo Municipal Airport permits hangar and flight research facilities for local flight test programs. The use of Government facilities throughout the country for missile flight tests, radar experiments, and aircraft tests has added to the Laboratory's experience. All of the Laboratory's facilities, of which only a few have been mentioned, are housed in a modern two-story building with over 350,000 square feet of work space.

At present, the Laboratory employs approximately 1,100 people, of which 400 are scientists and engineers, 350 are technicians, draftsmen and shop personnel, the balance being comprised of plant-protection, maintenance, clerical, administrative and executive personnel. Of the 400 professional people, over 100 have advanced degrees. The number of people at the Laboratory has increased from approximately 600 in about 1948 to the current level, and continued growth is planned.

The annual volume of business has increased from an average of \$3.4 million per year in the first five years of operation to over \$13 million per year at present.

The diversity of technical interest and talent in the Laboratory is shown by the organization chart.

~~SECRET~~

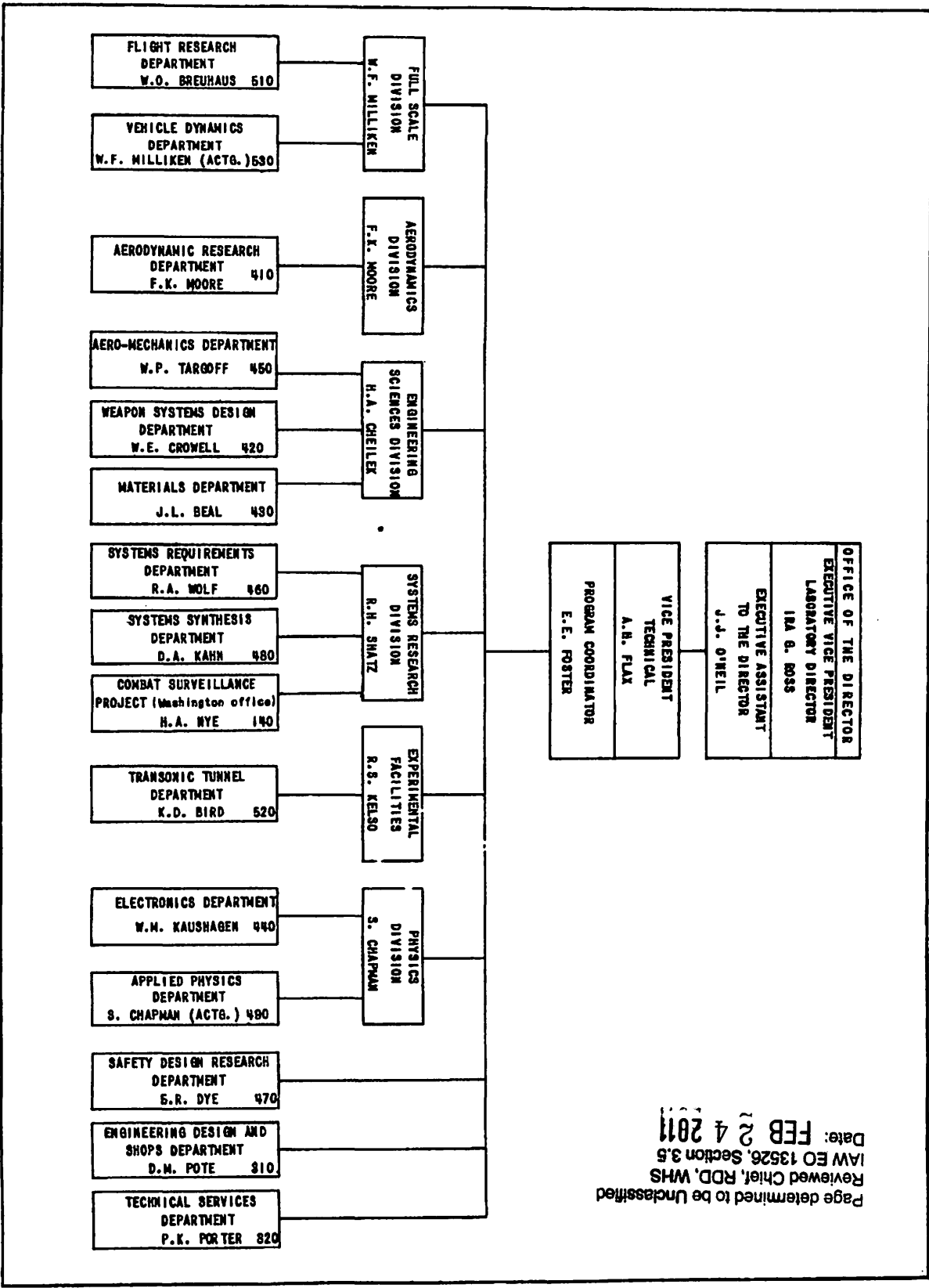

Page determined to be Unclassified
 Reviewed Chief, RDD, WHS
 IAW EO 13526, Section 3.5
 Date: FEB 24 2011

Page determined to be Unclassified
Reviewed Chief, RDD, WHS
IAW EO 13526, Section 3.5
Date: FEB 24 2011

~~SECRET~~

DECLASSIFIED IN FULL
Authority: EO 13526
Chief, Records & Declass Div, WHS
Date: FEB 24 2011

NAVAL SHIPS, LANDING CRAFT AND AMPHIBIANS IN LIMITED WARFARE OPERATIONS⁵

(b) Limited warfare conditions may, in certain important areas, determine future characteristics of new ships and equipment. Defense agencies recognize a limited number of possible localities and political situations that might involve the United States in the use of U. S. ships and equipment either by indigenous friendly forces or by U. S. forces. The Panel would like a discussion describing likely limited-warfare areas, the detailed geographical considerations for each area which influence ship, equipment and weapon design, and an outline of military strategy and tactics which would be effective in each situation.

Comment: It is recommended that recent WSEG (Weapons Systems Evaluation Group) reports on this subject be referred to.

(c) To what extent has the "vertical envelopment" of the Marine Corps been implemented to enable its use in meeting limited-warfare situations? At what approximate dates will the various degrees of availability of equipments for this concept be effective? What dates are planned for availability of the various functional water craft to support a "vertical envelopment"? In the long-range planning, to what extent will "vertical envelopment" displace conventional shore-line assault?

Comment 1: The Commandant of the Marine Corps has approved the reorganization of the three Marine divisions with the objective of making them air-transportable and their assault elements helicopter-transportable. The First Marine Division, at Camp Pendleton, California, has already been reorganized, and the Second Marine Division, at Camp Lejeune, North Carolina, and the Third Marine Division, at Okinawa, are now being reorganized. The significance of this reorganization is shown in the following examples:

(1) Reduction of personnel from 20,854 to 18,910. (This includes officer and enlisted, Marine Corps and Navy.)

⁵Extracts from memorandum, "Request for Information," from the Chief of Naval Operations to Chairman, Advisory Panel on Ordnance, Transport and Supply, OASD(R&E), 30 January 1958, signed by direction John T. Hayward.

~~SECRET~~

~~SECRET~~

DECLASSIFIED IN FULL
Authority: EO 13526
Chief, Records & Declass Div, WHS
Date: FEB 24 2011

(2) Removal or reduction of the following heavy equipment allowances:

18 howitzers, 155mm
24 howitzers, 105mm (instead of 54)
79 tanks
334 trucks heavier than 3/4 ton (instead of 730)
31 tractors (instead of 64)

These reductions have been accomplished primarily by substituting lighter equipment such as mortars, mechanical mules and multiple rifle carriers (ONTOS).

Subject to the following comments, the Fleet Marine Force will have the capability to land and support one Battalion Landing Team in each Marine division by the end of this fiscal year.

Comment 2: For all practical purposes the required landing-force equipment is now available with the exception of helicopter-transportable missile organizations for air defense and atomic surface-to-surface capability. The principal new transport helicopters, the HUS and HR2S, are in production and significant numbers are already in operating squadrons. During the period 1958-1961, Fleet Marine Force capabilities will be improved by the addition of:

(1) A Light Antiaircraft Missile Battalion.

(2) A helicopter-transportable medium artillery rocket battery with atomic capability.

Comment 3: As previously indicated, the Fleet Marine Force is capable of conducting limited vertical envelopment in amphibious operations today, but our naval capability is limited by the availability of suitable amphibious-warfare shipping. There is in the fleet today only one ship especially modified for vertical envelopment operations--the converted escort carrier USS THETIS BAY (CVHA-1). One new LPH (amphibious assault ship) and one LPH conversion (ex-CVE-106) have been funded for in fiscal year 1958, and they should reach the fleet in fiscal year 1961. The LPH is designed to carry 20 HR2S-type helicopters (one squadron) and 1,800 troops (one battalion landing team and the embarked helicopter squadron). Additional LPH are planned but not funded as follows:

1959 - 1	1963 - 2
1960 - 1	1964 - 2
1961 - 2	1965 - 2
1962 - 1	

If this program is achieved, there will be 13 LPH in the fleets by fiscal year 1968 (3-year lead time), leaving a shortage of three LPH to be

~~SECRET~~

~~SECRET~~

programed to achieve the Navy's long-range objective of 16 LPH by end of FY 1972. In addition to the LPH, the following types of amphibious-warfare ships have a limited helicopter-employment capability in the form of a helicopter platform:

AGC (amphibious force flagship)
APA (attack transport)
LSD (dock landing ship)
LPD (amphibious transport dock)

The long-range objective of the Navy is to provide amphibious lift for two Marine division wing air-ground task forces with vertical lift for the assault elements.

Comment 4: For the foreseeable future, a substantial portion of the men and materiel required to effect a lodgement on a hostile shore must still cross the beach in a "conventional" fashion. It is envisioned that the flexibility of the helicopterborne assault forces will be exploited to uncover and secure the beaches and to seize critical areas that will be required to enable us to phase in the additional means to maintain the momentum of the assault and secure the objective area. Helicopters will be employed initially to displace the assault elements of the landing force from ships at sea to attack positions ashore from which they can seize the critical terrain features. In subsequent operations ashore helicopters will be employed to maneuver disengaged units into attack positions from which they can launch an attack against critical objectives at a decisive time.

(d) The Panel considers that the Navy has been handicapped in the past by lack of support for the building of strictly experimental ships. Assuming that support for experimental ships could be obtained, what would be the three or four proposals of the highest priority for exploitation of new hulls, machinery and nuclear power and the interrelationship of these features? How far would these proposals depart from present practice?

Comment 1: It is submitted that careful considerations of the relative urgencies of programs requiring funding have dictated the policies with respect to experimental ship programs. The most urgent of such programs, i.e., the ALBACORE, have in fact been funded. The YAG-37 is another example of a ship employed exclusively in the experimental work. In addition, many programs are under way which are designed to provide information and data of an experimental nature during normal or between normal activities of ships in service.

The continuation of the ALBACORE work is of high priority, extending investigations now under way which involve the development of a bridge fairwater lift spoiler, maneuvering and emergency propulsion motor, improved stern configuration and braking devices. The installation of contrarotating

~~SECRET~~

~~SECRET~~

DECLASSIFIED IN FULL
Authority: EO 13526
Chief, Records & Declass Div, WHS
Date: FEB 24 2011

propellers (dropped from previous programs because of insufficient funds) is a high-priority item which should be included in future programs, along with other important areas of investigation. Increased propulsive coefficient, decreased propeller noise and decreased drag are expected to result from these projects.

There are areas of interest which are developing to the point where other experimental ships may be highly desirable in the future. The Bureau of Ships is conducting studies in the field of developing a small surface ship which will be effective as a sonar platform. Experimental model work is being done along this line. It appears that a full-scale "preprototype" should be developed in the near future in order to evaluate (a) various ship-quieting techniques involving major variations in propulsion schemes, appendage design, etc. and (b) sonar equipments under service conditions, both existing and experimental.

Hydrofoil research conducted since 1947 has resulted in the development of a high degree of design capability, both in the hydrodynamic and control areas. Several research craft have been built, and test work is still continuing. It is believed that a full-scale craft should be built that is capable of carrying a useful payload and/or performing a military function in order to demonstrate the suitability of such craft for naval uses. Examples of such applications are a hydrofoil LCM and a hydrofoil patrol craft in the 100- to 125-ton displacement range.

Other areas of desirable experimental work in ships include service-test work involving component testing of items, or combinations of items, such as the pressure-fired boiler, large propulsion gas turbines, and perhaps nuclear-conventional boiler plants which would combine high endurance with less total weight and initial cost. It may be that such component testing can be performed in a conventional-type ship which is not heavily committed to normal operations.

Comment 2: The need for experimental-type submarines to explore unknowns in the fields of hydrodynamics, high-speed ship control, radiated noise, self noise and unique propulsion systems such as the primary battery has been expressed by the Navy for the past few years. Project NOBSKA has supported the argument for strictly experimental submarines. These types of submarines can provide necessary information for the development of new equipments and techniques and new submarine characteristics. The ALBACORE at present is the only new strictly experimental submarine. In addition to researching the aforementioned broad fields, the Navy needs other experimental submarines to explore hull structure at great depths, integrated controls, sound quieting of nuclear power plants, the use of direct-drive turbines, primary batteries, large-horsepower electric motors, and counterrotating propellers to increase quietness and efficiency. The various types of submarines under construction or planned do incorporate some new features in nuclear propulsion, sonar, hull forms and controls. These items are not strictly experimental. Such

~~SECRET~~

~~SECRET~~

DECLASSIFIED IN FULL
Authority: EO 13526
Chief, Records & Declass Div, WHS
Date: FEB 24 2011

features must have a high degree of reliability and success designed into them. In other words, ideas which may fail have no vehicles in which to be evaluated. To employ experimental submarines for specific major evaluations of systems would be a dramatic break from the present system, which is most conservative and piecemeal in its approach, for the present system requires, first, a dependable combat submarine and, second, a minimum of radical departure from established engineering design.

~~SECRET~~

Page determined to be Unclassified
Reviewed Chief, RDD, WHS
IAW EO 13526, Section 3.6
Date: FEB 24 2011

~~SECRET~~

DECLASSIFIED IN FULL
Authority: EO 13526
Chief, Records & Declass Div, WHS
Date FEB 24 2011

NOTES ON WARFARE FOR LIMITED OBJECTIVES

William F. Whitmore
Bureau of Ordnance, Department of the Navy

Limited wars are part of the framework for opposing the spread of Soviet influence. In general, the areas of interest are those which possess natural resources now available to the West (Middle East oil or Malay rubber and tin) or have strategic geographical importance (Okinawa) or "prestige" value (Israel). Most of the countries involved are underdeveloped and have in the past been controlled by direct governmental links with the West--colonialism. The West is now striving to get the material benefits (raw materials) of colonialism while avoiding the political stigma. Thus the framework of which limited war is a part is first of all political (Department of State) and centers around the question "How do we persuade people to join our side?" Diplomatic action and foreign aid both military and nonmilitary, are part of the preplay leading up to the possibility of armed action and cannot be separated in national policy from the military aspects of limited war. The basic popular support for communism in the underdeveloped countries seems to come from the hope of a higher standard of living for the bulk of the population, with Red China supplying apparent evidence of such an increase for a "backward" Asian country. If Western aid can also give concrete evidence of better living for the people as a whole, rather than a small ruling class (Middle East, again), then the pull of communism will be greatly reduced. The chance of overt military action will be reduced--unless Russia gets desperate--and the acceptability of Western military support enhanced.

An important by-product of an increased standard of living would be to make it much easier for Western forces to fight effectively. Many of the difficulties of limited war operations in Southeast Asia, for example, result from the lack of roads, airfields and airways control centers, and communications networks. An increase in the country's standard of living and level of industrialization would tend to remedy these difficulties. Point 4 agricultural experts may, in the long run, contribute more to the effectiveness of limited-war operations than the furnishing of jet fighters.

It seems a reasonable hypothesis that the role of U. S. forces in limited war will be to supplement indigenous forces in the area of operations. Certainly the United States is in no position to intervene in a country which freely chooses to accept communism--there must be some

~~SECRET~~

~~SECRET~~

DECLASSIFIED IN FULL
Authority: EO 13526
Chief, Records & Declass Div, WHS
Date: FEB 24 2011

substantial element of resistance to justify armed action. U. S. assistance should cover specialized arms which are not available to the country in question--modern aircraft, fleet units, armor (where appropriate) and so on. It should also include at least a token land force to avoid claims that "America is prepared to defend you to the last native." At least this initial land force should be capable of quick reaction with adequate logistic support, to avoid placing impossible burdens on the local supply position. A jet aircraft wing arriving without adequate POL (petroleum, oil, lubricants) back-up would soon cease to be of much value.

The obvious answer to quick arrival is airlift, but several recent studies (as well as Air Force testimony before the Symington Committee on Air Power) indicate that this is out of the question for units of division size or larger. Even for smaller forces, some movement by sea is inevitable, unless the war is finished in short order. To speed up the operation, we are led to consider means for the rapid loading and unloading of ships--in the latter case, possibly by over-the-beach operations--and in general to consider forward positioning of forces and supplies. Okinawa and the Philippines are obvious Pacific locations; the NATO structure can be utilized in Europe, with possible application to the Middle East. A situation involving Pakistan would be difficult from this point of view. The aircraft carrier of appropriate size has an obvious application to limited-war situations as a floating, self-contained airbase which can be positioned to best advantage. Most of the probable areas of limited war are accessible to sea-based air, though Northern Siam, for instance, would cause trouble if Burma and Vietnam were neutral and could not be overflowed for political reasons.

The initial reaction force for limited war should be:

- (a) relatively small in numbers
- (b) capable of rapid reaction
- (c) as nearly self-contained as possible, including appropriate air elements
- (d) accustomed to operate with naval support

This, of course, is a thumbnail description of the Marine Corps and is its classic role in U. S. military history. Between World Wars I and II, the Marine Corps was made responsible for the development of techniques and tactics for amphibious assault.⁶ It might be worth while to give the Marines a similar R&D responsibility for the initial phases of limited war for operations involving U. S. forces up to a single division. Larger scale operations, which would inevitably develop more

⁶Isely and Crowl: The Marines and Amphibious Warfare.

~~SECRET~~

~~SECRET~~

slowly--over three to six months for deployment, would remain Army functions, as would the administration and implementation of military aid to indigenous forces. This "roles and missions" question may seem somewhat remote from R&D, but the Marines are the one outfit that has the capability and the desire to concentrate on limited-war problems, and the R&D program would be sharpened by the assignment to a single agency.

Some random comments on specific weapon needs for limited war follow: The purpose of limited-war operations is in general to persuade a group of people that they will be better off by cooperating with the West than with the Soviet Union. It is difficult to do this if the initial step is to kill large numbers of them and to devastate large areas of their country. It follows that the weapons of limited war should be precise in application, limited as far as possible to enemy military forces, and that strategic targets (the productive resources of the country) should not be attacked any more than is feasible. This leaves little scope for high-yield nuclear weapons in land combat but does suggest the importance of nonlethal special weapons (BW and CW) if these can be made militarily effective. As of 1955, the Army had no stated requirement for nonlethal munitions of this type and, even now, is able to budget for very little work of any kind on BW and CW. Optimum-fragmentation weapons are reported to be highly effective against personnel, perhaps in some circumstances better than nuclear weapons on a weight-for-weight basis. Knowledge of these weapons appears to be severely limited by current security policy, which may give a false emphasis to the usefulness of small battlefield nuclear weapons.

The use of nuclear weapons of any size in limited war is a matter for fierce debate. Perhaps the only sensible posture is that now adopted by the Marine Corps: Start out with conventional weapons but always retain the technical and tactical capability to shift to nuclear weapons if the enemy introduces them. This imposes a double burden on R&D and on the supply organization. Three uses of nuclear weapons in limited war have been suggested as offering some inherent possibility of moderation:

(a) Nuclear air-laid "mines" for deep interdiction of mountain passes in relatively uninhabited areas. These could form decisive road-blocks to the penetration of Chinese forces into Southeast Asia, or perhaps to Russian intervention in Iran.

(b) Nuclear attack on a Chinese seaborne invasion of Formosa. This might also apply to the more remote possibility of massive Soviet aid in Indonesia.

(c) Nuclear warheads in antiaircraft defense.

More generally, a principle has been proposed of the announced use of nuclear weapons against forces physically present on territory friendly to the West but not against the enemy homeland. This would offer an unanswerable case before world opinion, perhaps, but might quickly alienate the

~~SECRET~~

~~SECRET~~

"friendly" inhabitants. There seems much to be said for an R&D policy which would concentrate first of all on nonnuclear methods of handling limited-war situations.

One of the most bitter arguments on the technical side of limited war is the role of air power. It has been mentioned that full-scale air-lift is not now available and is not planned. The great value of the helicopter, or some more advanced VTOL system, seems well-accepted. Controversy continues on the desirable characteristics for close-support aircraft. There has been a strong tendency to produce fighter aircraft which could first win an air-supremacy battle and then serve for close support. The first requirement has led to a high-speed, high-altitude, short-endurance, fuel-hungry aircraft with little or no all-weather and night capability. The close-support aircraft desired by the ground forces could almost be described in exactly opposite terms, with particular emphasis on night capability and on adequate loiter time in the combat area at, say, 5,000 feet.

It is at least arguable that an all-out battle for air supremacy is incompatible with limited war as usually envisaged. Certainly, the likely course of U.S. action would be nuclear attack on sanctuary airbases if we were faced with heavy aircraft losses. In any case, it is not clear that the close-support aircraft must be identical with those opposing enemy fighters. The F-86 was not the work-horse close-support aircraft in Korea, nor could the AD have faced the MIG-15 in combat.

The present Marine Corps proposal for a successor to the AD, known as the XVA, represents a partial victory for this school of thought. Every attempt should be made to keep it from degenerating to a second-rate jet fighter and to increase its all-weather and night detection capabilities. A major lesson of Korea was the need for some effective means of locating and attacking enemy truck transport at night. In broad terms, the usual situation was that 10 percent of the trucks in use were seen, and 10 percent of those (one percent of the total) were effectively attacked.

The essence of the limited-war concept sketched here is collaboration on an equal footing with indigenous forces. This means a whole field of R&D work in devising force systems specifically for other than U.S. troops. It also means finding a method to communicate quickly and effectively with such troops across language barriers. Further, since Americans are notoriously poor linguists, this means some form of mechanized translation or nonverbal signal system. R&D for this should begin with an identification of the rather limited vocabulary to be transmitted. The mechanization of the system should then be relatively straightforward. Remember that, after Suez, it took four hours to transmit the first tactical order to the UNEF's multilingual personnel.

A final topic that must be mentioned is that of combat environment. It has been stated that the common denominator of most limited-war

~~SECRET~~

~~SECRET~~

DECLASSIFIED IN FULL
Authority: EO 13526
Chief, Records & Declass Div, WHS
Date: FEB 24 2011

situations is likely to be an underdeveloped country. But this underdevelopment can take forms ranging from the Middle East desert, through the mountains of Iran or Korea, to the tropical rain forests and mangrove swamps of Southeast Asia. At first sight, these may seem to call for specialized and varied weapon systems, vastly complicating the limited-war armory. The prologue to any study of limited-war weapons should be a catalog of possible environments, both the physical landscape and the physical and mental capabilities of the inhabitants, with a view to discovering as many common factors as possible to produce highly flexible basic weapon systems. If it should prove that certain specialized weapons are also needed, these should be held to a minimum and their value rated against the likelihood of their being needed--with a side glance at necessary lead times to get them into operation. A short lead-time item for an unlikely situation would evidently not command a high priority. One specific example of a weapon for a specific environment would be river craft for the exploitation of Southeast Asian waterways. Another might be some form of defoliant for jungle trees.

The preceding remarks are highly concentrated and quite dogmatic. It is believed that adequate background information exists for all the positive statements made, though not uncontroverted evidence in all cases. It is hoped that the paper will provide a stimulant for discussion and serve as a check-off list for relevant issues.

10 April 1958

~~SECRET~~

Page determined to be Unclassified
Reviewed Chief, RDD, WHS
IAW EO 13526, Section 3.5
Date: FEB 24 2011

~~SECRET~~

DECLASSIFIED IN FULL
Authority: EO 13526
Chief, Records & Declass Div, WHS
Date: FEB 24 2011

DOD COLD WAR INTELLIGENCE REQUIREMENTS -
FOR A CONTESTED FREE WORLD COUNTRY

Office of the Assistant to the Secretary of Defense
for Special Operations

1. The Communist Target.

(a) Communist Plan: What is the communist plan for taking over this country? How does this country fit into the over-all communist plan for world domination? How far along is the implementation of the communist plan in this country? What are the probable indications which will denote progress or failure in future phases of the plan? What are the immediate Soviet aims in this country?

(b) Communist Resources: What is the communist organization for operations in this country? Local apparatus; Soviet Country Team; third country base? Units, with strengths, locations, names and biographical data of personnel, and probable missions? Communications? Morale? Clandestine assets? Means of financing and obtaining physical resources? Inventories and location? What is the role of bloc official missions?

(c) Communist Operations: What is the communist modus operandi in this country? In the metropolitan areas? In specific rural areas? What are the main psychological and intelligence targets of the communists and what form do their operations take? Where and how are personnel trained?

(d) Potential Communist Weaknesses: Upon which individuals, who are not members of the Communist Party, do the communists rely? What are the relationships among communist operators and between them and non-communist leaders in communist-controlled organizations? How is discipline maintained? What is the relationship between individuals who have been in the apparatus for some time and members who have recently come from abroad? Are "self-criticisms" written or oral? If written, what disposition is made of these "self-criticisms"? What working alliances have been made with noncommunist groups, and who performs the liaison? Which communist units have a low standard of performance?

2. Target Groups.

What are the strengths, weaknesses, principal personalities, areas of influence, foreign contracts, and relationships with other parties of all important parties and factions? What are the principal rightist areas

~~SECRET~~

~~SECRET~~

DECLASSIFIED IN FULL
Authority: EO 13526
Chief, Records & Declass Div, WHS
Date: FEB 24 2011

of influence? What is the strength and orientation of the noncommunist left? Communist groups not oriented toward Moscow? "Third Force" groups? Religious? Labor? Veterans? Educational? Who are the most important individuals in the government; who are the most likely successors to the incumbents in posts of power? What are their backgrounds, beliefs and standards of public morality? If any of these need more training and experience for leadership, who are they and what do they need? Who are the most important foreigners residing in the country on a long-term basis? What are their activities and motivations?

3. Armed Forces.

What is the organization, strength and unit location of the national armed forces? Who are the most influential officers? (Give biographic data.) What is the political indoctrination of the armed forces and how is it carried out? What are the present or potential morale problems of the armed forces and what is the actual or probable effectiveness of countermeasures, if any? What is the degree of subversion by communist or other dissident groups? Their methods? Types and numbers of probable subversive agents? What organization is there in the armed forces for countersubversion? What is its strength, capability, training? What is the relationship between the armed forces and various levels of the civilian population? How well-informed are the officers and men with regard to communist objectives and methods, their country's history, the organization and functioning of their government, the rights and obligations of citizens under their constitution, and current events?

In the case of a country whose armed forces have engaged in combat with communist or dissident forces, additional questions are: Which officers and units have been most successful against the communist forces and other dissidents? What was their successful tactical doctrine?

4. Influence of Military Leaders in Civil Government.

What is the political orientation and motivation of influential military officers? Which military personalities with influence have ideological motivation? What is this motivation? Who are outstanding younger officers with potential and aspirations for political leadership? What is the role of the military in society? What are the social levels from which members of the officer corps are drawn? To what extent is there military participation in public works, e.g., communications services, engineering projects, etc.? What is the outlook of the military leaders with respect to their military history, background and tradition? Which officers have been to U.S. schools? (Give biographic data and any continuing ties with U.S. officers.) Which have been to other foreign schools? Are there any marked antipathies between the services? Between the military services and security or police forces?

~~SECRET~~

~~SECRET~~

DECLASSIFIED IN FULL
Authority: EO 13526
Chief, Records & Declass Div, WHS
Date: FEB 24 2011

5. Security.

What are the organizations other than the armed forces for maintaining internal security? What are their strengths, capabilities, methods, training, equipment, loyalties, morale, deficiencies? From what elements of the population are security personnel recruited? What are the criteria for selection? Where are political prisoners imprisoned? How are they handled and by whom? Is any propaganda or "re-education" directed toward such prisoners? What are the interrogation methods used and what is the degree of their success? Are prisoners tortured or otherwise maltreated? In what ways? What are the objectives, strengths, capabilities and tactics of armed dissident forces? Who are the dissident leaders? What means are being used to counter this dissidence? With what effect?

6. Population.

Is the population homogeneous; if divided, is it along ethnic, economic or other lines? Any problems resulting from population pressures? Are there any foreign or recently arrived elements in the population? Where are they and of what importance are they to the life of the country? What ties do they have with foreign countries?

7. Culture and History.

What are the best ways of winning the friendship and trust of the people in this country? What manners, actions and symbols cause their mistrust and enmity? What are current popular notions of humor, morals and good taste? What specific factors contribute most to national pride? What are the 100 most useful phrases in the principal language of the country? What are the most current slang expressions? What is the popular concept of the more important events in the history of the country? Who are the national heroes? What is the image of these heroes in the popular mind? What are the principal educational institutions? Criteria for admission of students? Sources of financial support for students? What programs exist for foreign exchange of students?

8. Press, Radio and TV.

What are the principal media of information in this country? How much influence has each newspaper, broadcasting station, etc.? What is the orientation of each? What form does censorship take? Law? Import licenses on newsprint? Influence through advertisers? Other? Who are the owners, editors and important staff members of each? What is their orientation? What is the source of newsprint, equipment, etc. in the case of each? What foreign publications and broadcasts have influence in the country? What is the effect?

~~SECRET~~

~~SECRET~~

DECLASSIFIED IN FULL
Authority: EO 13526
Chief, Records & Declass Div, WHS
Date: FEB 24 2011

9. Public Opinion.

What do the people in rural areas, in villages, in towns and in the cities think of their government? Do the people identify themselves with their government? What views are held of the government by professionals, students and other intellectuals? In what ways do the people express their views to the government? How responsive is the government to these expressions? Through what organizations can the people express themselves? Veterans groups? Youth? Labor? Professional? Civic organizations? What role do religious organizations play? Who are the religious leaders? What measures does the party in power take against its opponents? What national government organizations reach the village level? By what means and with what effect? What opinions are held of the United States, the Soviet Union, Communist China, neighboring countries, and U. S. allies?

10. Economy.

How large a national defense force can this country maintain out of its own income? What are the most important developments and trends in the economy of this country? What groups and individuals control business and industry? Who controls key elements in the economy, e.g., public utilities, banking, food distribution? What role is played by foreign capital? By foreign entrepreneurs and managers? In what particular areas and enterprises is native capital being invested? Why? What are the normal business ethics? Is there any trend noticeable in business ethics? Do important political or military leaders have concealed investments? How prevalent is smuggling, tax evasion, and bribery of public officials?

11. Foreign Aid.

What are the trends in foreign aid to this country (military, economic, technological)? What role is played by each foreign country in this aid? What are the objectives of this aid and to what degree are these objectives being attained? From the viewpoint of the giving country? From the viewpoint of the receiving country? What is the importance of the time factor? Who are the important personalities, whether native or foreign, in projects of foreign aid?

12. Practical Geography, Climate, Public Health, etc.

How do factors of geography and climate influence the development of the country? What is the state of health of the people? Which diseases take the greatest toll of lives and work hours? How are public and private health institutions coping with the situation? Principal shortcomings?

9 June 1958

~~SECRET~~

~~SECRET~~

DECLASSIFIED IN FULL
Authority: EO 13526
Chief, Records & Declass Div, WHS
Date: FEB 24 2011

"PACIFICATION" IN VIETNAM⁷

Col. Edward G. Lansdale
Deputy Assistant to the Secretary of Defense,
Special Operations

This is in response to a recent request from CINCUSARPAC for information on this subject, to facilitate CAMG planning for PACOM countries. Apparently no reports or documents on the subject are available in the Pentagon. The information below is drawn from personal experience, including that of Chief, National Security Division, Training Relations & Instruction Mission (TRIM), Vietnam. TRIM was a combined French-U.S. mission commanded by Lt. Gen. John W. O'Daniel, Chief MAAG-Vietnam.

Situation After Geneva

The problem facing the Free Vietnamese in late 1954 was how to establish their government in areas south of the 17th Parallel held by the Communist Vietminh. The Cease-Fire Agreement, signed by the French and Vietminh at Geneva 20 July 1954, provided for the withdrawal of Vietminh located south of the 17th Parallel by increments--specific assembly points were designated, with specific dates for withdrawal (mostly to sea-ports for sea transport to North Vietnam). There were four such assembly areas south of the 17th Parallel, with varying deadlines (from 20 July 1954):

Xuyen-Moc, Ham-Tan Area80 days
Central Vietnam (Quang-Ngai, Benh-Dinh) Area - first increment.	.80 days
Plaine des Joncs Area	100 days
Central Vietnam - second increment.	100 days
Camau Area.	200 days
Central Vietnam Area.	300 days

These areas had experienced eight years of war. Bridges were blown, highways destroyed by cross-ditching, railroad lines sabotaged, the economy was at a standstill (rice lands fallow, transport destroyed, markets in

⁷Memorandum for the record, "'Pacification' in Vietnam," by Colonel Edward G. Lansdale, Deputy Assistant to the Secretary of Defense, Special Operations, 16 July 1958.

~~SECRET~~

~~SECRET~~

DECLASSIFIED IN FULL
Authority: EO 13526
Chief, Records & Declass Div, WHS
Date: FEB 24 2011

ruins), and disease and hunger were rampant. In addition, as the Vietminh withdrew openly, they left stay-behind organizations for covert political, psychological, and paramilitary operations. It was the evident Communist intent to continue the domination of South Vietnam secretly.

The Geneva Agreement of 20 July 1954 was specific concerning the peaceful measures to be employed in the take-over of these areas. This meant that something different had to be devised other than the "pacification" measures of the French Army during the years of war (such as those started with the Tonkinese in 1950 in the Red River Delta and Operation "Atlante" in Central Vietnam in 1954; French Army officers familiar with such operations include Brig. Gen. Jean Carbonnel, former Chief of Staff of TRIM, and Col. Jean Roman-Defosses, my former Deputy at TRIM).

The Free Vietnamese had just started governing themselves. There were only a few trained, experienced government administrators. Of the Vietnamese civil service personnel, 80 percent were in the capital city of Saigon; largely experienced as minor functionaries under French administrators, they were mostly city-dwellers with no desire to accept government positions out in the "wild," troubled countryside of the provinces.

The only nationwide organization in the Vietnamese government was its National Army. Its battalions were stationed throughout the country, with communications to headquarters in the national capital, and with an officer corps with some training and experience in leadership and administration; nearly all field-grade officers had college educations (a rarity in Vietnam then). Thus, it was decided to make use of the Vietnamese National Army as fully as possible in extending the administration of the government in Saigon over the provinces, including areas from which the Communist Vietminh were withdrawing under the Geneva Agreement.

Unfortunately, there were complications in using the Army for this extending of central government authority. During the first period of 100 days after the Geneva Agreement, there was considerable plotting within the Army to overthrow the government (led by the Chief of Staff, General Hinh, and marked by murders of officers, rebellion of units, desertions, etc.). The loyalty of the Army to President Ngo dinh Diem had to be established; this was finally accomplished in December 1954.

Another complication was equally serious. The Army was typical of forces in Asia and the Mideast, used to imposing its will on civilians by force of arms and weakened by poor logistics (which in turn offered opportunities to some grafting officers). The result was that the man in uniform was not the best representative of the new government--he was accustomed to mistreating civilians at check points and to obtaining his food gratis from civilians by the weapons he carried. The National Army soldier was in sharp contrast to the Vietminh soldier who served under

~~SECRET~~

~~SECRET~~

"fish in the water" and who conscientiously made friends with civilians as a helpful "parade", to fulfill the Chinese communist dictum that "the people are the water and the soldier is the fish."

Early Measures

Under informal American auspices (usually in my house, at my personal invitation), meetings were held in August 1954 between Vietnamese government officials and Vietnamese Army staff officers to work out a modus vivendi for establishing the government throughout South Vietnam. The provision of neutral (American) "good offices" permitted bringing together officials who were deeply suspicious of each other, including staff officers who were plotting a coup and government ministers who would be targets of the coup. An uneasy team of Vietnamese civil and military officials was formed. "Indians" who would carry the brunt of the work for the "chiefs" were selected and taken, under American guidance, to the Philippines for first-hand observance of Philippines Army-Government teamwork in stabilizing former communist Huk areas. (The operations of Civil Affairs Division, Department of National Defense, Republic of the Philippines, from late 1950 through 1954, provide excellent examples of the use of armed forces in re-establishing government authority against communist politico-military opposition. Methods developed there have been adapted successfully in Malaya, Vietnam, Laos and Burma. Major Jose M. A. Guerrero, Philippine Army, has personal knowledge of the work of the Civil Affairs Division during the entire Huk campaign.)

The Vietnamese team, plagued by the internal strife of South Vietnam, worked out methods for occupying the "80 days" and "100 days" areas south of the 17th Parallel being vacated by the Vietminh. These methods were only partially employed and had only partial success.

The resolution of the Army coup plotting in December 1954 and plans for U.S. participation in the training of the Vietnamese National Army finally opened the way for concrete organization, planning and operations for solution of the problem.

National Security Action

By the end of 1954, the experiences of the French in their pacification work in the Indo-Chinese States, the British in Malaya, and the Filipinos in Luzon, the Visayas and Mindanao had been studied and methods then developed for use by the Vietnamese. To provide a legal basis, directives were developed for issuance by the President, the Minister of Defense and the Armed Forces General Staff (the latter two being implementing directives of the President's policy guidance). English translations of these directives, in seriatim, are attached as Annexes A, B and C.

The new Vietnamese government had an antipathy for the French colonialists with whom they had struggled for freedom. Thus, the Vietnamese rejected use of the French term "pacification" and substituted a Vietnamese

~~SECRET~~

~~SECRET~~

term translated as "national security action." The two terms were interchangeable and were usually referred to as "pacification."

After issuance of the Presidential directive on 31 December 1954, implementation needed to be worked out quickly. The take-over in Camau was to start on 8 February 1955; conditions in areas already evacuated by the Vietminh and elsewhere were hardly favorable to the Vietnamese government and required constructive action. At the same time, permission for U. S. participation with the French in working officially with the Vietnamese Army was proceeding with diplomatic sedateness. Something needed to be done, so General O'Daniel quietly jumped the gun and informally initiated the cadre for TRIM, organized into divisions for Army, Navy, Air and National Security. The National Security Division was to advise and help the Vietnamese with national security action. Advice was to be given discreetly. The Divisions of TRIM alternately had a chief of one nationality and his deputy of another. The National Security Division had an American chief, a French deputy and a combined staff of both nationalities; there was some difficulty in operating, owing to this Division's mission of giving sensitive politico-military advice to Vietnamese who mistrusted the French. (The Vietnamese at times solved this by presenting false operational plans at staff conferences and keeping actual plans secret.)

There were two immediate problems in national security action. One was in organizing the operation to take over the Camau area, starting 8 February. A commander needed to be appointed, a staff organized, logistics planned, troops assigned and trained for pacification duties. Col. Duc, an officer loyal to the President and with previous pacification experience, was appointed. American advisers moved into his field headquarters and quietly helped him get his organization, plans and training under way. (In late January, the French came in and assisted.) Troop training for pacification was assigned to the Vietnamese G-5 (Psychological Warfare and Troop Morale), with Americans quietly helping devise and implement the program. Condensed instruction was given (by Vietnamese, based on a course of instruction developed by the Americans) to groups of instructors, who then were assigned to troop units as they moved into assembly areas. These quickly trained G-5 officers then instructed all officers in the units to which they were assigned, the unit officers, in turn, training their own troops. This hasty instruction was assisted by demonstrations (how to enter a village, how to greet civilians and how to pay for goods) and by skits enacted by G-5 teams, often on the backs of 6x6 Army trucks--good and bad soldiers were portrayed, playlets given illustrating answers to communist propaganda and how to handle a communist-inspired demonstration, along with talks on collecting operational intelligence and locating hidden arms caches. The appearance of the individual soldier was improved by the issuance of standardized equipment and uniforms and by rigorous inspections.

The second immediate problem was to obtain Defense and General Staff directives implementing the Presidential directive of 31 December 1954. This required some quiet encouragement by American advisers--in the

~~SECRET~~

~~SECRET~~

DECLASSIFIED IN FULL
Authority: EO 13526
Chief, Records & Declass Div, WHS
Date: FEB 24 2011

Presidency, the Ministry of Defense and the General Staff. Finally, the Minister of Defense (Ho Thong Minh) organized and chaired a meeting in Saigon, 3-5 February 1955, attended by all civil and military leaders concerned with pacification throughout the country. Personnel attending included cabinet ministers and general staff officers down to provincial officials and arrondissement commanders.

At this meeting (which included some remaining French holding civil and military positions in the Vietnamese government), there was unusually candid reporting on conditions in each area of the country and equally frank remarks about the Presidential directive. The Defense Minister explained the directive, taking particular care to describe the zoning and the government's desire to transfer local authority as quickly as possible from military to civilian control. Zoning was one of the key factors in pacification. In case the attached directives are not clear, the following outlines how the zoning actually worked (with a little help in the Presidency to obtain decisive actions); each province, sometimes part of a province only, was classified according to its condition of law and order and then placed under the proper authority:

Pacification zone (many dissidents and acts of violence): The Army commander had full civil and military authority, usually with an appointed civil Province Chief as an adviser.

Transition zone (law and order being established, but Army patrols still required): Depending upon each local situation, the top authority was either a military commander with a civil deputy or a civil official with a military deputy.

Civil zone (law and order again established): Under civil administration.

Camau Operation

The occupation of Camau was carried out by Vietnamese Army units roughly equivalent to a U.S. Army division, under the command of Col. Duc and with a staff put together for the operation. (At the time, the Vietnamese National Army was organized in battalions, battalions being grouped into a temporary task force when larger missions so required.) The Camau occupation was given a name, "Operation Liberty." Battalions were moved up into jump-off positions along the border; transport was readied (with only one entry road, small boats were needed for transport on canals and rivers); headquarters was set up at Soc Trang, which had a concrete landing strip for transport aircraft.

While the troops were being hurriedly readied, intelligence operations were carried out in the Vietminh-occupied area. (Incidentally, this is the communist area visited by the American journalist Joe Alsop, who wrote a series of newspaper and magazine articles about this trip behind the

~~SECRET~~

~~SECRET~~

"Bamboo Curtain" just prior to Operation Liberty). Until late in 1954, intelligence collection in Camau had been carried out by G-6 of the Vietnamese National Army. (G-6 was called "Military Security" but was patterned to some extent after the French Army's G-5 in Indo-China, with an organization for intelligence collection and unconventional warfare in denied areas, as well as a capability for carrying out politico-military measures, such as goon-squad secret actions.) G-6 had been active in Army coup plotting against the government and was restricted at the end of 1954. G-2 was still French-controlled and, due to Vietnamese mistrust of the French, was little used for this intelligence mission. Most of the intelligence operation was locally improvised by the commander, Col. Duc, with the personal help of President Ngo dinh Diem, who defected a Vietminh military unit, which was then successfully employed in intelligence and unconventional warfare missions.

Intelligence reports indicated that regular Vietminh military units, with dependents, were departing on schedule from their west-coast port of embarkation, but that political and intelligence nets were organized for stay-behind, and that a covert paramilitary organization was preparing a base in the Go-Cong, a drowned mangrove forest on the west coast of the Camau peninsula. (These reports were later confirmed.)

The operation began on 8 February. Troops were preceded by an air-drop of leaflets, which explained the peaceful mission of the Army and asked the people not to be afraid. Speeches by President Diem to the troops and to the population had been put on tape and were used by prepapanda teams of the Armed Propaganda Company organic to the Army's regional headquarters. USIS worked closely with National Security Division and Vietnamese G-5 in developing tapes, leaflets and posters used in Operation Liberty. This same close teamwork continued in later operations.

Many of the troop units arrived too late for training, neither officers nor men understanding their mission. Thus, in the early days, there was little success except for areas occupied by trained and well-motivated units. Some of the units simply moved into their designated areas and then sat in idleness. There were many incidents of stealing food, molesting of women and similar misbehavior by these untrained troops. These errors were gradually corrected. The trained, indoctrinated units would immediately establish law and order, act as disciplined soldiers and lend helping hands to the civilians in rebuilding ruined public markets, bridges and dwellings. Army engineer units built bridges and roads.

The Army had attempted to organize some military government teams (GAMs), to establish local government under Army authority. These teams were undermanned and had little training for this duty. Thus, most of the government authority established in villages was done locally by unit commanders after a quick loyalty check of village leaders. The ex-Vietminh unit defected by President Diem became a scouting force and was usually the first to enter a village. It carried out the security screening, uncovered Vietminh stay-behind nets and located hidden Vietminh arms caches. Many

~~SECRET~~

~~SECRET~~

of these ex-Vietminh became local leaders and have demonstrated loyalty to the anticommunist Diem government.

A comment on these ex-Vietminh is required. They were noncommunist, like the vast majority of the Vietminh who fought the French during the eight years of Indo-China War. The communists captured the Vietminh movement, which was largely a struggle to establish a free and independent Vietnam, by placing Party personnel in key control positions. Some Vietminh military leaders were convinced noncommunists, who were most resentful at having to serve under Party members of lesser military ability. Thus, after Geneva, some Vietminh leaders and units deserted. It was such personnel who swore loyalty to Diem for the Camau occupation; their backgrounds were well-known to officials in the Presidency.

Aside from these ex-Vietminh, there were two other outstanding organizations in Operation Liberty: the propaganda teams of the Armed Propaganda Company and the Filipino medical teams of Operation Brotherhood. Both deserve fuller description.

Propaganda Teams: The propaganda teams were 20-man squads composed mostly of combat soldiers who had been trained in psychological warfare and who were selected for their patriotic motivation. They were armed for commando combat, if necessary, weight being given to automatic weapons. Teams were equipped with hand-portable public-address equipment (U.S. Navy "loud-hailers" such as used by beach masters and "little bull horns" developed commercially in the U.S. for use of police and firemen). Some larger French voice amplifiers, tripod-mounted and requiring a squad to set them up, were part of company equipment but were carried only by several teams. These French amplifiers were excellent, carrying a voice for five kilometers. The teams also carried leaflets, booklets and posters. These were resupplied from central stocks held by the Armed Propaganda Company headquarters which moved with the command headquarters. The teams also carried phonographs, films, film projection equipment and simple medicines (mostly for giving first aid to civilians).

These teams were attached initially to Army units as they entered the occupation zone. Once the Army unit had established its headquarters and explored its particular area of responsibility, the propaganda team operated within the area on its own, selecting its own targets. The teams were successful in penetrating remote regions, attracting crowds through the distribution of simple medicine (such as aspirin) or showing of movies--and then talking to the crowd to explain the peaceful mission of the Army and the aims of the Free Vietnamese Government and then distributing leaflets and booklets.

One successful trick used by these teams was to offer villagers a bright new colored picture of President Diem in return for the villager's old faded picture of the communist leader, Ho Chi Minh, which had been hanging in his hut for years. Exchanges were made readily in most cases.

~~SECRET~~

~~SECRET~~

DECLASSIFIED IN FULL
Authority: EO 13526
Chief, Records & Declass Div, WHS
Date: FEB 24 2011

The teams knew that if they entered the huts and pulled down the pictures of Ho Chi Minh they would only anger the villagers. This successful picture exchange became a standard procedure in pacification operations.

Operation Brotherhood: The Vietnamese Army Medical Corps was an embryo organization. At the last minute before Operation Liberty, some of the very few Vietnamese civilian doctors were drafted and immediately sent to Camau. Lack of preparation made this operation not too successful. As a substitute, Army units distributed mosquito netting, soap and blankets to civilians where these items were most sorely needed. The Vietnamese Army refused generous offers by the French Red Cross and French Army medical teams, stating that the Vietminh agitators would exploit the presence of French with the Vietnamese Army, claiming this Army to be mere puppets of the French. The French were deeply hurt by the ungracious turn-down of their offer and unjustly accused American advisers for making the Vietnamese so act; they forgot that the Vietnamese had been their enemy in eight years of war.

The outstanding medical and public health work was carried out by Filipino volunteer doctors, nurses, dentists and nutritionists of Operation Brotherhood. This organization had been founded shortly before by the International Junior Chamber of Commerce, its leading spirit, organizer and operational leader being Oscar Arellano, a young Filipino architect, who was then Vice-President for Asia of the International Jaycees. Operation Brotherhood was privately funded; many Americans contributed. Initially, the teams were all Filipino volunteers. Later, many nations contributed medical volunteers to the teams.

The esprit de corps of the Filipino volunteers of "OB" was a major factor in overcoming communist political work. These were Free Asians, who cheerfully and energetically helped their fellow men--in strong contrast to the grimness of life during the long war. The Filipinos had defeated the communist Huk guerrillas at home and imparted hope for the future. The OB teams made up their own songs, held parties in off-duty hours and were a real tonic to the dispirited. (Many an American on MAAG duty in the provinces was later "adopted" by the OB Filipinos and will confirm this psychological impact.) One side effect of the presence of pretty Filipino girl doctors, nurses, dentists, and nutritionists was that many a male Vietnamese started learning English so he could talk to them.

The first OB team moved into Camau with the leading troops, establishing their first "hospital" on packing crates by the side of the road. The Army turned over a building for OB and the Filipinos established a field hospital for the people of Camau who had been without medical aid for years. Despite the smallness of the team, this hospital was kept open and operating 24 hours a day. When additional Filipinos arrived, field teams were formed and traveled throughout the area, not only doing medical work, but

~~SECRET~~

~~SECRET~~

DECLASSIFIED IN FULL
Authority: EO 13526
Chief, Records & Declass Div, WHS
Date: FEB 24 2011

instituting public health measures, distributing soap and mosquito netting, giving inoculations, teaching malaria control and conducting classes in nutrition. At the hospital, they trained local Vietnamese volunteers in nursing and hospital operation, so that a going institution could be turned over to the Vietnamese to run for themselves.

Comment: Perhaps the highest compliment paid to OB was by the communists, who not only singled it out as a propaganda target but also imitated it. Later, in North Vietnam, medical teams of foreign "volunteers" (mostly white Czechs, who looked too much like the French to win acceptance) were sent into the provinces. The East Germans established and operated an excellent hospital in Hanoi. Chinese "volunteer" teams attempted social welfare work similar to that of OB, suffering considerable loss of face when the Filipinos showed Vietnamese farmers how to build fish ponds just south of the 17th Parallel, which the Chinese failed to do.

Preparatory Work: The Camau operation had many faults. Most of these were caused by a late start and considerable lack of understanding by Vietnamese officials, with resulting poor preparation and execution. The initial good effects of the psychological effort wore off when there was poor follow-through of action, particularly by the troops. Thus, there was only partial success in turning the Camau population's loyalty to the Vietminh into real support of the new government--a task we knew was not an easy one but a task that had to be done.

The National Security Division, working closely with Vietnamese officials, started planning for the remaining take-over of a Vietminh area, in Quang-Ngai and Binh-Dinh provinces in Central Vietnam, as soon as personnel could be freed from Camau support work. The first task was to take a hard look at the successes and failures of Operation Liberty. A study of "Lessons Learned in Camau" was prepared in English, French and Vietnamese, and copies were circulated to all staff sections of Vietnamese Army headquarters, Vietnamese ministries and TRIM divisions and to U.S. and French economic and information missions. (A copy of this study is not available for inclusion in this memo.)

A commander, Col. Kim, was appointed for the operation. He was the outstanding staff officer of the Vietnamese Army, the former "chef de cabinet" (executive officer) of the Ministry of Defense and Chief of the General Staff. His home province was Binh-Dinh. Although pacification was strange to him, he quickly grasped the principles. An operations plan was drafted and was presented to a combined staff of Vietnamese, American and French military and civil authorities, who critiqued the plan and were then given work assignments. By this time, the new Central Vietnam operation had received a name (from G-5), "Operation Giai-Phong" (meaning "breaking of manacles").

One thing was made plain. Every action of the Vietnamese National Army and of civil authorities was to be keyed to its psychological value

~~SECRET~~

~~SECRET~~

DECLASSIFIED IN FULL
Authority: EO 13526
Chief, Records & Declass Div, WHS
Date: FEB 24 2011

with the people in the area. As quickly as troop units were designated, their special training and indoctrination was begun; frequent inspections ensured that training and indoctrination were being carried out thoroughly. Intelligence on conditions in the area, its people and customs was included in the indoctrination. The minimum training received by any unit which finally participated was 30 hours.

As soon as an operational task force staff was formed, intelligence collection was stepped up. The operational area consisted of one province and half of another, lying along 150 miles of coastline south of Hue and Tourane. The area was noted as being the cradle of rebellion in Vietnam, its agrarian socialism being turned to communism in the 1930s. During the Indo-Chinese War, French movements into the area were mostly met by scorched-earth resistance. The Vietminh had a strong hold on the area.

Intelligence indicated that the Vietminh had restored some of the destroyed railroad running along the coast, but bridges were still down. The highways were still largely destroyed through cross-ditching. Famine was reported in some areas where no rice had been seen for eight years, and local land was impoverished. Most of the people in the area had had no medical attention for years. On top of this, as the number of civilians volunteering to go north with the Vietminh Army started dwindling, the Vietminh made a decision to take all the youth north with them, by force if need be; initially, this was youth down to 12 years of age, then later to 8-year-olds. Families started to hide their children in the hills.

Preparation continued. The Vietnamese Medical Corps was strengthened, principally by corps men; doctors remained scarce. Supplies were stock-piled for shipment to designated storage points in the operation area, including 2,000 tons of rice for distribution to the population. Operation Brotherhood was invited to establish a hospital just north of the operational area, from which they could move teams in with the troops. Twenty armed propaganda teams (including personnel from Operation Liberty) were attached to units. "Psywar" officers (specially trained for Operation Giai-Phong in psychological warfare, public relations and morale action-troop information and education) were attached to all units assigned to the operation. Over 300 civil service personnel were trained in local administration, to establish civil government in the villages under the Army commander. (There was partial conflict later as partisan politics received impetus through the new National Movement for Revolution Party, which was just being organized.)

The Operation Giai-Phong commander was assigned a G-5, who coordinated all psychological actions. He had a staff of some 20 officers and men, equipped with mimeograph machines, a portable photographic laboratory and radio receivers for news broadcasts. The armed propaganda teams attached to the units had psywar equipment and medicines as they had in Camau; in addition, they had portable bulletin boards to set up in market places of

~~SECRET~~

~~SECRET~~

DECLASSIFIED IN FULL
Authority: EO 13526
Chief, Records & Declass Div, WHS
Date: FEB 24 2011

villages when occupied. Several tons of leaflets, posters and other material were prepared well in advance. A motion picture, showing the better side of the Camau operation, was prepared and used.

Comment: As in Camau, the Vietnamese gave permission for only one American officer to accompany the troops--in civilian clothes. In Camau, he worked mainly with the G-5. For Operation Giai-Phong, he became the operational commander's adviser. Lt. Rufus Phillips, III, of the National Security Division of TRIM, served in both operations. His duties included being an expeditor on the spot, as did those of other U.S. officers in this division, which maintained an assigned radio channel during the operation. If supplies or supporting action requested by the operational commander were not forthcoming, word was radioed back and National Security Division officers would then follow through with the Vietnamese General Staff or government ministry indicated. This means of expediting worked extremely well.

Operation Giai-Phong: The operation began on 22 April 1955. There were last-minute changes of troops assigned, caused by the United Front actions of sect forces and the need for troops in Saigon-Cholon and the west, where the National Government fought the Binh-Xuyen and Hoa Hao. By this time, the Vietnamese National Army was being reorganized into regiments. Forces assigned to Operation Giai-Phong initially were nearly equivalent to a U.S. corps; the need for troops elsewhere reduced this at the last minute to about the equivalent of a light division. (The involvement of National Security Division, TRIM, in attempting to resolve the problem of these sect forces and the street fighting in Cholon around TRIM and MAAG headquarters added difficulty to staff support.)

The population had been heavily indoctrinated by the Vietminh that the Vietnamese National Army would pillage and misbehave, as they had at times during the war. Instead, each soldier and unit behaved extremely well, and the people lost their fear. After the first hours of the operation, civilians started bringing out bowls of water for the troops marching in. The soldiers, in turn, who had not been particularly enthusiastic about the necessity for good behavior, began to go out of their way to offer their services to civilians at rest stops, such as cutting wood or hauling water. The friendliness of the troops passed by word of mouth rapidly throughout the area with snowballing effects--the soldiers and civilians becoming more friendly and helpful to each other with each passing hour, until the advancing troops were greeted with flowers and cheering crowds, and soldiers eagerly pitched in to help with reconstruction. Not one single incident of misbehavior was recorded in the entire operation.

The Vietminh had demanded that the occupation be done in successive zones from north to south. There was evidence that they had hoped to build resistance to the Vietnamese Army, but the exemplary behavior of the Army boomeranged on the Vietminh. As the last of the Vietminh pulled

~~SECRET~~

~~SECRET~~

DECLASSIFIED IN FULL
Authority: EO 13526
Chief, Records & Declass Div, WHS
Date: FEB 24 2011

out, they were booed by the population and some rocks thrown at them. A good share of the reason was that Vietminh propagandists had told a number of lies to the people, and the Vietnamese Army was quick to preceive and exploit this. Some of the lies concerned Vietminh paper currency (which became drastically devalued), expected aid from Russia and China, promised atomic power plants and other similar promises. The Army made effective use of a mimeographed newspaper, published daily by the G-5 section with the operational commander and distributed by bicycle messenger to all villages.

Medical stations were established throughout the area and were treating 10,000 people daily at the height of the operation. Army engineers reconstructed bridges and highways, as well as building landing strips. Free rides were given to civilians on Army vehicles, dramatizing what good roads meant, while demonstrating the Army's good will. Critically ill civilians were evacuated to hospitals by air; such events were photographed by Army photographers and then printed for leaflets and for use on village bulletin boards. Such help gave real meaning to the Army's slogan, "The people and the Army are Brothers." As buildings in the villages were reconstructed, the Army established public schools, temporarily using Army personnel as teachers.

One of the major effects of this type of operation (well proven in Vietnam, the Philippines, Laos, Malaya and Burma) is that the "raw take" of operational intelligence increases greatly as troops show a brotherly attitude towards the people. This is vital when operating against covert forces hidden among the people themselves. In Operation Gial-Phong, information volunteered by the civilian population led to the seizure of tens of thousands of land mines, grenades, rifles, mortars and ammunition secretly cached by the Vietminh before departure. Their stay-behind nets were disclosed as well.

A week after the last Vietminh troops left the port of embarkation, President Diem made a surprise visit to the area. In Qui Nhon, an estimated 30,000 people gave him an enthusiastic welcome, to the considerable surprise of foreign military, diplomats and journalists. The welcome could not be organized, as it frequently was elsewhere, as there was only several hours of advance notice. Visits to small towns brought crowds of 10,000 from the surrounding countryside. The warm enthusiasm of the population was an indication of the effectiveness of the pacification campaign among a million Vietnamese who had been under communist control for years.

Civic Action

The Americans serving in the National Security Division, TRIM, had long been interested in other means to extend government administration throughout the provinces, working particularly with the Ministries of

~~SECRET~~

~~SECRET~~

DECLASSIFIED IN FULL
Authority: EO 13526
Chief, Records & Declass Div, WHS
Date: FEB 24 2011

Social Action, Education, Public Health and Youth and Labor, as well as the Delegate for South Vietnam. Shortly after Geneva, these Americans encouraged the work of the Ministry of Social Action in introducing self-help, community development programs (public safety, public health and primary schools mostly) in areas surrounding Saigon. These Americans also taught methods of secret balloting (with symbols designating candidates for illiterates) for electing community officials.

Comment: Pat Byrne and Anita Lauve, both of the U.S. Foreign Service and serving in the Saigon Embassy political section, observed this work in some of the worst slum areas of Saigon-Cholon noted as communist hotbeds. The girls made a big hit with the people by bringing large sacks of hard candy and distributing them to the children. This gave a real "fiesta" air to the elections.

One of the most promising ideas of this period came from Kieu Cong Cung, who was sponsored by Defense Minister Minh. Cung's idea was to place civil service personnel out among the people, in simple dress, where they would help initially by working alongside the people, getting their hands dirty when necessary. The Vietnamese functionaries were aghast, since they cherished their desk work in Saigon and their dignified white-collar authority, and they fought hard within the government machine to kill the idea. It took some months, with the personal intervention and insistence of President Diem, to get a pilot Civic Action program initiated. It was given administrative support by the Ministry of Defense, at first, simply because no other ministry would help, although it was established as an entity of the Presidency and its policy decisions were made in Cabinet meetings.

With 80 percent of the civil service personnel stationed in the national capital, provincial administrators were so understaffed that few of them could function with even minimum effectiveness. A French colonial administrative system, superimposed upon the old Vietnamese imperial system, was still the model for government administration. It left many gaps and led to unusually complex bureaucratic practices. There was no uniform legal code, no uniform procedures for the most basic functions of government. The communists continued their political dominance of many villages secretly.

Cung established a training center in Saigon and asked for civil service volunteers for field duty. With none forthcoming, he then selected a small group of young, university-trained men from among the 800,000 refugees from Communist North Vietnam after security screening. Cung was working on a shoestring, so his training had added realism in the form of rough living quarters and outdoor classes, and students learned to work with their hands by constructing school facilities. All students had to dress in the "calico noir" of farmers and laborers, which became their "uniform" later in the villages. (Provincial authorities originally

~~SECRET~~

~~SECRET~~

DECLASSIFIED IN FULL
Authority: EO 13526
Chief, Records & Declass Div, WHS
Date: FEB 24 2011

refused to recognize Civic Action personnel as government officials, owing to the plebian dress. Cung, dressed in the same manner, and as a high functionary close to the President, made a rapid tour of the provinces and gained grudging acceptance of this new style of government employee.)

Originally, 4-man teams were formed. During training, the members of each team were closely observed to judge compatibility, the weak and unwilling being weeded out. After graduation, each team was assigned to a district of a province with responsibility for a number of villages. When the team finished its work in the first village, it would move to a second village, revisiting the first village periodically to check on local progress. This would continue until all villages in a district were covered, at which time the civic action team directly under the governor in the provincial capital would take over district work, now organized and ready for administration.

When a team entered a village, they would call a village meeting, explain their presence and plans. The following morning, they would set to work to build three community buildings with local materials. If they had been successful in winning over the population, the villagers pitched in and helped. One building was a village hall for meetings of village officials; another was a primary school; the third was a combination information hall (news, information about the government, etc.) and dispensary (using the village medical kits developed by ICA). Following up was the building of roads or paths to link the village with provincial roads; if in a remote area, the building of pit latrines, undertaking malaria control, putting in drainage and undertaking similar community projects. Villagers were trained to take over these tasks, including primary education and first aid.

The work of Civic Action teams, at the same grass-roots level as that of communist workers, proved effective. They became the targets of communist agents, with political attacks (such as stirring up local Cochinese against Tonkinese Civic Action personnel) and then murders. Even while the field work was in its early development stage, President Diem ordered the teams to start working directly with Army commands in pacification campaigns, as the civil government "troops" in what were essentially combat zones. As Civic Action proved itself, it was extended to all provinces south of the 17th Parallel.

Civic Action was adopted by the Royal Laotian Army for its pacification work and then by the Royal Lao government. U Nu of Burma was so impressed by Civic Action in Vietnam that he arranged visits by the Burmese Army staff, who used its own adaptation with success along the Chinese border. It should be noted that the Vietnamese, Laotians and Burmese who developed their own local programs all had visited the Philippines to study similar operations there which had been initially sponsored by the Department of National Defense under Magsaysay to counter communist operations at the grass-roots level and later were taken up by civil agencies of the government.

~~SECRET~~

~~SECRET~~

DECLASSIFIED IN FULL
Authority: EO 13526
Chief, Records & Declass Div, WHS
Date: FEB 24 2011

Later Developments

Vietnamese National Army national security action (or pacification) and Civic Action, working together, formed the basic pattern for bringing security and stability to the countryside. There were later refinements and additions, but the basis had been established.

One excellent later addition was the Village Self Defense Corps, under the Ministry of Defense and developed with MAAG help. Volunteer villagers were security-screened, given training and weapons and then formed into a village guard for local defense. Local military commanders were given responsibility for these units. Military inspectors were trained and continuing inspection was established.

Comment: Those Americans who have criticized Ngo dinh Diem as a "dictator" should be interested in the underlying philosophy he reiterated time and again while struggling to get the Self Defense Corps established. He wanted the population armed as far as possible, since an armed citizenry, with rights and responsibilities under a responsive government, was the one thing which communism could not tolerate and remain alive. He was thinking of communism as a dictatorship and was fully aware that an armed citizenry, earning the right to bear arms, would oppose any dictatorship.

In a later operation, the government experimented with forming a pacification task force built around Garde Civile (national constabulary) forces, Civic Action teams, and strengthened by a company of Army Security troops. This was only partially successful and finally was given up in favor of using larger Army units.

In the campaign against the Hoa Hao sect forces of Soai and Ba Cut in mid-1955 it was interesting to note that the operational commander, Col. Duc (who had commanded Operation Liberty), started in immediately training troops assigned to him with courses on behavior, with emphasis on the customs and history of this religious sect. President Diem appointed a political adviser with long local experience to work with military commanders in the various operations against dissident sect forces.

Final Comment

It is a wise soldier who learns the weapons of his enemy. The communists have been highly successful in combining political-psychological action with their military action. The political-psychological section of the communist forces not only equals the conventional forces in command and staff authority from small units up through the highest headquarters, but in numerous operations has actually provided the senior commander. This is particularly true of communist guerilla or partisan forces. In many countries where there are U.S. MAAGs and Missions, the first communist enemy opposing the work of U.S. military men is usually the political-psychological soldier, frequently operating covertly. He is a skilled and dangerous enemy with many successes to his credit.

~~SECRET~~

~~SECRET~~

DECLASSIFIED IN FULL
Authority: EO 13526
Chief, Records & Declass Div, WHS
Date: FEB 24 2011

In making use of local armed forces to stabilize the situation internally, with heavy use of political-psychological action, the American should remember that in many countries of the world today, particularly in the so-called "emerging" countries of new nationalism, this type of action is actually the borrowing of a weapon from the enemy. Just as we have Americanized other weapons we "borrowed" from past enemies, so should this one be Americanized.

Our political principles, our history and our own military education all speak plainly on how to Americanize this weapon. Following the precepts well known to you, it becomes relatively easy to advise a foreign army on command extending down from a top civilian authority representative of the people of the temporary nature of martial law, of true military courtesy expressed in relations with civilians. All you need is the ability to recognize bad soldiering by U.S. standards, to figure out corrective actions and to set out to correct them with tact and patience.

With such guidance, a national armed force can become the most important stabilizing force in a troubled country, constructing a firm basis for political and economic development, without establishing a military dictatorship or without building up such popular resentment against the military that our enemies can capture the populace.

~~SECRET~~

~~SECRET~~
(Vietnamese)

STATE OF VIETNAM
PRESIDENCE OF THE GOVERNMENT

Annex A
(Copy of English
translation by
Vietnamese official)

PRESIDENTIAL DIRECTIVE
No 278/PTT/QP/M of 31st
December 1954

DIRECTIVE
ON NATIONAL SECURITY AND MAINTENANCE OF ORDER

The aim of this Directive is to determine the mission of the FAVN in the course of National Security action in newly occupied territories and for the maintenance of order in the controlled territories.

The directive calls to the attention of all territorial Commanders and for all Unit Commanders (territorial units, field units in regional mission) who may have to participate in national security action or in the maintenance of order. It will be effective on 1st February 1955.

I - DEFINITION OF THE ZONES

The territories on which the Armed Forces may be called for action are classified into three categories:

1) National Security Zones

The following are classified National Security Zones:

- a) - normally, the zones which have been recently evacuated by V.M. Troops.
- b) - When requested by the Civil Authority, the zones in which insecurity takes such an extent that it evades the control of the security forces.

In these zones, the military command has the responsibility of National Security action; it may be assigned a G.A.M. (Administrative mobile Group) the mission of which is specified hereafter (case of the newly occupied zones) (See annex III and annex I).

2) Transition zones

Transition zones are those where National Security action conducted by the Army has been carried far enough to allow the installation of the Civil Authorities on a final basis.

~~SECRET~~
(Vietnamese)

~~SECRET~~
(Vietnamese)

The responsibilities for National Security action and maintenance of order previously handled by the Military Command only will be progressively taken up by the Civil authorities.

3) Civil Zones

In the civil zones, full authority is given to the Civil Administration which has usually at its disposal only its own security forces.

The Armed Forces come into action for the maintenance of order only upon requisition from the Civil Authority.

- 4) The decision to transfer responsibilities from one category to another is taken, after agreement of both Civil and Military authorities by the next higher echelons.

II - MAINTENANCE OF ORDER MISSION

- 1) In the territories controlled by the civil authorities (civil zones), the maintenance of order rests with these authorities.
- 2) Due to the inadequate number of civil police forces, the Armed forces provide the bulk of the armed elements participating in the maintenance of order missions.

However, according to the use made of the Armed Forces for this mission, they are divided into 2 categories:

- 1) The Gendarmerie and the so called "territorial" units.
- 2) The units of General Reserve (Divisional and nondivisional) and the ministerial units.

Forces of the 2nd category can be used only under special conditions:

- inside the garrison at all times, provided that they can be rapidly relieved from their missions.
- for missions lasting less than 24 hours after agreement of the Region Commander.
- for missions lasting more than 24 hours after agreement of the General, Chief of the General Staff (1)

(1) Request to be forwarded to General Staff - 3rd Bureau.

~~SECRET~~
(Vietnamese)

However, some General Reserve units can be placed provisionally at the disposal of the Territorial Command, on orders from the General, Chief of the General Staff.

These General Reserve units are then said to be "on Regional Mission."

3) The following Civil Authorities are entitled to request the assistance of the Armed Forces:

- The Delegate from the Government at the regional level.
- The Chiefs of Provinces.
- The Provincial Delegates.

It is compulsory for them to apply to the corresponding levels in the military Chain of Command:

- Commander of the Region
- Commander of the Arrondissement
- Commander of the Sub-Arrondissement.

4) In every case, the military Authority has the obligation to give satisfaction to the Civil Authorities, according to the means at his disposal. If he deems it necessary, request for additional means must be sent to the higher echelon. However, it must be pointed out that the Armed Forces remain for the carrying out of their mission under the sole command of their Chiefs.

The Civil Authorities entitled to request the assistance of the Armed Forces can assign a mission only to the military territorial authority of corresponding echelon, but they are not allowed to issue orders to the troops whatever their functions may be.

5) In a case of extreme emergency, Military Chiefs can take under their responsibility to apply the indispensable measures to re-establish order. The military Authority must then report without delay about the initiatives taken in that respect, both to the Civil Authority of corresponding echelon and to higher military commander.

6) A close coordination must permanently exist between the Chief of Province (or the Provincial Delegate) on one hand, and the Commander of the Arrondissement (or Sub-Arrondissement) on the other hand, the latter acting as Military Adviser to the Civil Authority.

The Intelligence Officer (G2) of the military commander will then act as his Liaison Officer.

7) The missions of the Armed Forces are four-fold:

- Permanent acquisition of intelligence information.

~~SECRET~~
(Vietnamese)

~~SECRET~~
(Vietnamese)

- Preventive action
- Assistance in cleaning-up anti-subversive operations.
- Action to re-establish order.

a) The acquisition of Intelligence information must be centralized and guided:

- Particularly, permanent relations must be established between the 2nd Bureau, the Gendarmerie and the Security and Police Services.
- Any information urgently needed must be the subject of a special request submitted to the responsible civil Authority.
- Meetings attended by the representatives of the various Intelligence Agencies must be held periodically.

b) Preventive action:

It splits into two categories of action:

- Direct preventive action
- Indirect preventive action

- Indirect preventive action:

Are part of this category, the changes made in the deployment plan of the units, the parades and maneuvers. This action is carried out at the initiative of the Military Command.

- Direct preventive action:

Are part of this category the planning for a security plan and its initiation, restriction to quarters, reinforcement of guards, the use of special patrols, particularly of night patrols, guarding of vital points, police rounds.

This action can be carried out either at the initiative of the Military Command or upon request of the Civil Authority who, in any case, must be kept informed.

c) Antisubversive operations:

They include:

- Day and night searches of private houses.
- taking into custody.
- systematical searches.

~~SECRET~~
(Vietnamese)

~~SECRET~~
(Vietnamese)

Army participation in these operations must be limited to surrounding of places and assisting police forces who are the only ones normally allowed to carry searches or to take persons into custody.

d) Action intended to re-establish order:

- Dispersal of unlawful assemblies.

This action must be assigned in priority to armored or truckborne elements provided with smoke grenades and tear gas. However foot troops will be frequently used. They must always be used in masses at least of a company strength.

This resort to force will not normally imply the opening of fire: Other steps must be taken to disperse unlawful assemblies of unarmed persons.

However, if this show of force and the use of ruses to disperse unlawful assemblies do not give any result, then the use of arms must be visualized.

- Use of arms in case of extreme emergency.

Troops may use their arms:

1. If violences and assault and battery are committed against military personnel.

2. If they cannot defend by any other means the places it is their mission to guard, or if in the performance of their mission, the Command, aware of this fact, issues orders to go through at any cost.

In these two cases, however, the troop Commander must as far as possible warn the opponents or assailants by repeating in a loud and firm voice (1) that orders to use arms are going to be issued. These orders must always be followed by a first volley fired in the air.

- Use of arms upon request from the Civil Authority.

The use of arms to disperse an unlawful assembly or for any other purpose must always be requested in writing by the Civil Authority. Explanatory reasons for this request will be given to the higher authority within the shortest possible time.

(1) Using loudspeakers if possible.

89
~~SECRET~~
(Vietnamese)

~~SECRET~~
(Vietnamese)

DECLASSIFIED IN FULL
Authority: E0 13526
Chief, Records & Declass Div, WHS
Date: FEB 24 2011

In this case, warning that arms are going to be used must be given by a trumpet-call (or several strokes of a gong) and by challenging the risters twice (1).

Challenging should be done, in principle, by the Civil Authority (Chief of Province and delegate); however he can delegate the authority to the Commander of the Troops.

Before acting, the Commander of the troop temporizes as long as the security of his troops or the accomplishment of his mission will allow.

III - NATIONAL SECURITY ACTION

1) National Security action is carried under full responsibility of the military authority.

2) National Security action covers all measures taken for the maintenance of orders as specified at Chapter II, but both Military Authority and Civil Authority are in the hands of the military Command as regards these missions.

3) In the beginning, it is necessary that the Military Command display energy in order to establish its authority. However, when the first days of occupation have elapsed, it will be necessary to comply with the principles defined at chapter II, particularly as regards anti-subversive operations and re-establishment of order.

4) In addition to the National Armed Forces and the Gendarmerie, the Military Command has at its disposal the Police and Security Services forces and Mobile Administrative Groups (G.A.M.).

IV - RELATIONSHIP BETWEEN THE ARMED FORCES AND THE G.A.M.

The GAM's are organized by the Civil Authority who is in principle the representative of Government Authority at regional level.

Relationship between the units carrying out national security action and the GAM's are specified hereunder:

During the period when National Security Action is controlled by the Military Authority, the GAM's work under the responsibility of the military Chiefs in the same way as a normal military unit. Government directives concerning the civilian functions of the GAM's will be forwarded through the normal channels to the responsible military chief who, in return, will

(1) Using loudspeakers if possible.

90
~~SECRET~~
(Vietnamese)

~~SECRET~~
(Vietnamese)

have to make sure that the provisions of these directives are carried out. In case of discrepancy between Military Instructions and Civil instructions, the matter will be brought up before the higher military authority to be settled in agreement with the corresponding civil agencies. In the Transition zones, the GAM's will be progressively withdrawn as the setting up of the Civil authorities proceeds.

V- DEPLOYMENT OF VARIOUS TYPES OF UNITS

Owing to the above-specified missions, units will be deployed according to the following principles:

Outside the special case when they are assigned to guard a vital point, the troops will be grouped in quarters, but never in posts. (However, some posts may be temporarily used as quarters, but the guard duty will be kept to a minimum.)

a) Territorial organizations:

As a general rule, each Infantry Battalion will be kept grouped. Companies could be detailed for some missions assigned to the Battalion, but these missions should not go below platoon level.

Artillery units will be kept as often as possible at battalion strength or at least at battery strength.

b) General Reserve units:

- In all cases, with the exception of units said to be on "regional mission" (1) the infantry battalion and the artillery battalion will be quartered in a single place.

- Armored units are quartered by troops as a minimum strength. However, some combat platoons could be detailed to be placed at the disposal of Arrondissement or Sub-Arrondissement Commanders for missions of maintenance of order or opening of roads, but the platoon should never be broken down into patrols as regards quartering.

- To put the above principles into effect, numerous posts and towers will have to be abandoned.

- If their use is deemed necessary during the application of the local security plan, they should be guarded as often as possible by regional or provincial forces. An agreement should be reached in that respect with the civil authority.

(1) Units assigned to N.S. action duty are said to be in "Regional mission."

91
~~SECRET~~
(Vietnamese)

~~SECRET~~
(Vietnamese)

DECLASSIFIED IN FULL
Authority: EO 13526
Chief, Records & Declass Div, WHS
Date: FEB 24 2011

- Some posts or towers which are not considered being necessary any more will have to be demolished after agreement with the Civil Authority. It will be the case, particularly, for numerous towers built along the roads, provided that these towers are not necessary for the guarding of bridges.

SAIGON, 31 December 1954
The President of the Government
Signed: NGO DINH DIEM

92

~~SECRET~~
(Vietnamese)

~~SECRET~~
(Vietnamese)

DECLASSIFIED IN FULL
Authority: EO 13526
Chief, Records & Declass Div, WHS
Date: FEB 24 2011

INCLOSURE 1

ARMED FORCES ACTION

Soldiers responsible for national security action will behave in accordance with the following principles. These principles will be applied to a various degree according to the importance of the active resistance met.

1) The installment of the authority of the State of Vietnam will be marked by a ceremony to which troops of the State of Vietnam, selected among the best trained, the better equipped and the most disciplined, will participate.

2) Proclamations will be made or posted, telling the names of local civil and military authorities, announcing the immediate control steps that have to be taken, specifying that these steps are only temporary and intended to insure the protection of the population against unlawful elements, if such elements exist.

3) The GAM's will assume control and checking of any person of influence holding an important post, such as the Chief of the Village or the Chief of Police.

a - Notables will be carefully screened as regards their competence and loyalty. Those already in function who give satisfaction will be maintained in their posts under the checking of GAM's.

b - As soon as possible, all local Government posts will be assigned to reliable civilians working under the supervision of GAM's.

4) In the National Security and Transition zones under military command, Military Law and Military Police regulations are the only ones enforced.

5) Any hostile action from an individual will be immediately punished according to its degree, but carefully avoiding to compromise the necessary cooperation between the Armed Forces and the population.

6) Military personnel will assist the civil services until they are able to perform their own management, for example, in matter of medical supplies, drinkable water and food supplies, and to start and operate indispensable public services.

93
~~SECRET~~
(Vietnamese)

~~SECRET~~
(Vietnamese)

7) Reconstruction programs will be launched everywhere without delay on the Military Command's advices. As far as the situation and the security will allow, deployed troops and local materials will be used, if possible, with the assistance of the Engineers. As regards the use of local civilian manpower, care must be taken to avoid any abuse and not to give any ground material to communist propaganda and trouble making. Reconstruction programs will cover initially roads, schools, dispensaries, religious buildings and markets.

8) The GAM's will organize local social action by setting up social action committees able to establish improvement programs with a minimum of outside help.

9) Population will be given the opportunity to file claims against military personnel participating in National Security Action, against the GAM's or against underground VM troublemakers, without fear or reprisals. Every effort will be made to take the necessary action without delay. To this effect, it is strongly advised to install mail boxes on the village square or at any other convenient place.

10) The local military Command will indicate the hours at which the inhabitants may come to him without any pre-arranged appointment to talk about any matters pertaining to National Security.

11) Psychological action teams from Psychological action regional units could be attached if requested to units engaged in National Security Action down to battalion level inclusive. These teams will support National Security action with their own means such as movies, leaflets, posters, records, loudspeakers etc. in order to persuade the population to trust the Vietnamese Government, and to reduce VM prestige.

12) The military commanders will make every effort to get accurate information and to use it at the proper moment to support their mission. They will organize a network of intelligence agents to work on a goodwill and private relations basis, and to try to show what advantages can be drawn from cooperation and what inconveniences may result from a non-cooperative attitude.

In addition, by dispatching patrols, daily contacts will be maintained with all parts of the zone under military Command.

94
~~SECRET~~
(Vietnamese)

~~SECRET~~
(Vietnamese)

STATE OF VIETNAM

Annex B
(Copy of English
translation by
Vietnamese official)

MINISTRY OF NATIONAL DEFENCE

H.T.T.S.
No. 398/VP/QP/M

MINISTERIAL DIRECTIVE
ON NATIONAL SECURITY AND MAINTENANCE OF LAW AND ORDER

The No. 278-PTT/QP/M Ministerial Directive of 31.12.1954, on the FAVN functions during the N.S. action in newly occupied territories and on the maintenance of law and Order in controlled territories, stipulated that in case of extreme emergency, military chiefs may take the responsibility of applying the necessary measures for the re-establishment of law and order; and stated the use of weapons in that same case of extreme emergency.

The aim of this directive is to specify what must be understood as a case of extreme emergency; to define it, to determine its different characteristics and to enumerate the main cases.

The words "extreme emergency" designate an event caused by a greater force than that of a man which cannot be turned aside nor subjugated and the consequences of which cannot be attributed to anybody.

An event has a character of extreme emergency only if it is unsurmountable in nature and a simple difficulty in carrying out orders cannot be so considered. In the same way, an event which can be controlled or avoided is not a case of extreme emergency.

Moreover this event must be beyond the control of man. It is an exterior cause which cannot be charged to the person responsible for the maintenance of law and order.

Also the event has to be unforeseeable. But unforeseeableness is estimated in a general and abstract way. The following will not fall under extreme emergency cases classification: inherent defects of material (weapons and ammunition, cars...) for which one is responsible, or traffic accidents caused by road condition, headlights dazzle, tires bursting.

Neither a limitative nor a quite complete enumeration of extreme emergency cases can be given. However it is possible to list the main cases:

- Natural forces: The atmospheric events (tempest, flood...) which cannot be surmounted nor foreseen are cases of extreme emergency.

95
~~SECRET~~
(Vietnamese)

~~SECRET~~
(Vietnamese)

The military commander may have to take the responsibility to apply necessary measures for the re-establishment of law and order, in a territory under control of civil authorities and in which these authorities are responsible for the re-establishment of law and order, if he is prevented by natural forces, to warn for action the civil authorities of a disturbance or when he is convinced that those authorities are prevented by natural forces to reach the proper place to stop the disturbance.

- The fact of a third person is a case of extreme emergency when it cannot be prevented nor foreseen. Generally, this is the case of an action carried by several unknown people, but it may also be the case of an action carried by an unknown individual. That would be the case of several people who come and:

- surround a place which the troops are ordered to guard.
- surround a quarters area for the purpose of cutting off food and ammunition supplies.
- block an itinerary the troops have to follow.
- block a way with movable articles so that the troops cannot destroy the road block or go through it without endangering their lives.

It is also the case when one or several individuals exert violence or assault and battery against troops on duty, although this might well be a case of self defense.

The attention of the Military Command is drawn on the fact that it must avoid as much as possible blood effusions, bearing in mind though that the authority of the National Government should not be diminished, especially in N.S. zones. If public order is disturbed or threatened, it has to be quickly re-established by resorting to force if necessary. But, before resorting to force other processes have to be used; so, the use of ruses, the show of force. On the other hand it must not be overlooked that the resort to force must not always and necessarily involve the opening of fire.

Saigon, February 9, 1955

THE MINISTER OF NATIONAL DEFENSE

Signed: HO THONG MINH

96
~~SECRET~~
(Vietnamese)

~~SECRET~~
(Vietnamese)

ADDITIONAL CIRCULAR

Annex C
(Copy of English
Translation by
Vietnamese official)

for the conduct of National Security
action in the N. S. Zone

- - -

(attached to circular No. 398/VP/QP/M
dated February 9, 1955)

STATE OF VIETNAM

MINISTRY OF NATIONAL DEFENSE

GENERAL STAFF

G-3

February 15, 1955

REFERENCE: Presidential circular No. 278/QP/M, dated December 31, 1954

A. The behavior of troops, their relations with civilians and G.A.M.
will substantially remain the same as in TRANSITION ZONES.

B. Additional steps to be taken.

1. Supervision of the population.

A census will be made of all the members of each family (the family head being held responsible); their names will be registered in a control book and a copy will be kept in the office of the Chief of District (G.A.M.).

2. Supervision of the family.

A list of the inhabitants, authenticated by local authorities, will be posted in each house.

In every district, a temporary permit of residence will be delivered to every transient by the local authorities, after introduction by the landlord and under his responsibility.

3. Travel

An identity card without picture, but with fingerprints (except for town dwellers) will be delivered free of charge by the Administrative Authorities and authenticated by the Military Authority.

The identity card for town-dwellers will bear a picture.

97
~~SECRET~~
(Vietnamese)

~~SECRET~~
(Vietnamese)

4. Self-purging and self-screening in villages.

Every village will be divided in several hamlets, to enable families, in groups of 3, to screen each other; each group is supervised by a Chief of hamlet.

The Chiefs of hamlets are supervised by the Village Chief or the Police Commissioner.

5. Order and Security

A national guard will be created in each village; its strength will be determined by the Chief of district, in accordance to the number of inhabitants. The Chief of the National Guard is responsible for order and security in the village.

Under no circumstances, can the National Guard be utilized for reaching private objectives.

A network of secret agents will be organized in each District, the village being thus the smallest antenna of the system.

6. Curfew

Curfew hours will be established. Armed patrols will enforce it. Individuals who have infringed the curfew will be punished and will be submitted to a thorough investigation.

7. Military Control operations.

They will have an aggressive and mobile character. Light detachments will be found and specially trained for night raids.

The action of these detachments which may be assisted by local guides and agents (wearing, if necessary, military uniforms) must permit to track all V.N. political meetings and to destroy all concentration or movements of guerilleros.

8. Psychological Warfare.

Psychological warfare (conducted by light detachments linked with the Operational Units) will be organized in order to destroy the enemy's morale, to increase his fear and to induce him eventually to surrender, in the hope of finding a better life.

Ostentatory propaganda means (loud speakers, movies, etc...) will be utilized moderately and only when it will be found advisable.

98
~~SECRET~~
(Vietnamese)

~~SECRET~~
(Vietnamese)

9. Monthly Control of the National Security Action.

A monthly meeting, at the Arrondissement or Province level, in which will take part the Arrondissement Commanders, the Province Chiefs, the Commanders of Subarrondissements, the Liaison or General Staff officers, will permit to determine the results reached by National Security Action, to state the main difficulties and to recommend the proper solutions.

10. Miscellaneous

a. Political courses for the Arrondissement and Subarrondissement Commanders.

Schedule.

- Studies concerning the V.M.:
 - V.M. political organization in the village.
 - Schedule of V.M. action in the evacuated areas.
 - Tracking of V.M. agents holding functions in the village administration.
- Studies concerning the operation of the administrative apparatus.
 - Administration rudiments
 - Political organization rudiments
 - Economic organization rudiments.
 - Social organization rudiments.

All these studies will be conducted by G.2., jointly with the Administrative and political Services of each Government Delegation in the different Regions.

Procedure: Lectures will be appointed by the General, Chief of Staff, and the Government Delegates in the different Regions.

The duration of these courses and their location will be determined by each Region Commander with the agreement of the Government Delegate.

b. Rewards for important information.

Rewards will be attributed to recompense any information permitting the capture of guerilleros or the surrender of arms or ammunition.

99
~~SECRET~~
(Vietnamese)

~~SECRET~~
(Vietnamese)

DECLASSIFIED IN FULL
Authority: EO 13526
Chief, Records & Declass Div, WHS
Date: FEB 24 2011

The V.M. soldiers who surrender will be given a fair trial and, if they are sincere and have committed no crimes, the Government may grant them advantages, such as resettlement.

c. Weapons register and license system.

All previously issued licenses to carry or own a weapon will be revised to insure that no weapon is held by any individual capable of using it to disturb public order.

100
~~SECRET~~
(Vietnamese)

~~SECRET~~
(Vietnamese)

GENERAL DIRECTIVES

STATE OF VIETNAM

for the conduct of N.S. Operations in
Transit areas (joined to the No. 398/VP
QP/M of 9.2.55 Ministerial Instruction
for the reinforcements of the Presiden-
tial Directive)

MINISTRY OF NATIONAL DEFENSE

GENERAL STAFF

G-3

No. 0831/TIM/3/EG
Clt 31.210
S.P. 4002, 15.2.55

REFERENCE: Presidential Directive No. 178/QP/M of 31.12.54

A. BEHAVIOR OF MILITARY PERSONNEL

The behavior of troops during the NS operations will be guided by the following principles:

1. Each one will behave in an exemplary manner both after and during duty hours.
2. The behavior of each soldier toward the population will be brotherly and protective. By this behavior, Forces will compel respect and admiration from the people.
3. Every endeavor will be made to demonstrate to the population the high level of discipline, state of mind, competence which prevails among the Armed Forces.

B. RELATIONSHIP WITH CIVILIANS

The objectives to tend will be the following:

1. To secure public safety.

a. Control measures

The control measures previously taken will be lessened to a minimum and suppressed as soon as possible.

- b. Behavior toward V.M. agents and arrested suspects:

In transition zones under civil authority V.M. agents or any person suspected of subversive activities will be arrested by the civil Authorities and committed to Military Law.

Relevant orders will be issued so that the arrested suspects are not mistreated by soldiers. Interrogation minutes will be made accordingly.

101
~~SECRET~~
(Vietnamese)

~~SECRET~~
(Vietnamese)

DECLASSIFIED IN FULL
Authority: EO 13526
Chief, Records & Declass Div, WHS
Date: FEB 24 2011

2. To win the population confidence.

a. By campaigns of hand-assistance to the population

During the works of harvest, cultivation, house-building, or even arrangement of flats or houses and removals, teams of picked soldiers of irreproachable behavior will be sent; they will be the "apostles of National Cause" for directly taking part in the life of the inhabitants.

This assistance will be chiefly reserved for the following peculiar cases:

- poor families
- families of widows and orphans
- families of war-injured men
- families whose head is at the front line or in the Forces
- damaged villages or areas.

These teams will remain all day long with the families, they will bring their food-rations and will have their meals at the same time than the members of the family, they will be in the work done for the benefit of the family.

The aim of this "co-existence" the length of which will vary according to the nature of the work is to achieve the conquest of the minds and to ascertain the true feelings of the population.

The results observed and pursued by cadres, also selected, will be recorded and reported to the Chief of Arrondissement who will submit them for study at each monthly N.S. briefing.

It will be recorded in Monthly Report to Superior Authorities.

To sum up, the inhabitants, treated as loyal citizens of a Liberating regime, will be led to choose themselves the regime which they will defend against any current sabotage or future threat.

b. The presence of troops not a trouble for the population.

Billeted outside agglomerations, the troops will have to get their supplies from militaries sources.

Those coming from civil sources, reduced to a minimum, will be quickly paid.

They will have to respect scrupulously personal property.

They will not impose obligations or fatigues of any sort to the population.

102
~~SECRET~~
(Vietnamese)

~~SECRET~~
(Vietnamese)

3. To reinforce the fidelity of the population toward the Government of Free Viet-Nam and the Armed Forces.

a. Exposing all the aspects of V.M. politics as the aim of which is:

- to destroy all the family morals
- to suppress all economical and commercial liberties
- to bring the people down to poverty then to slavery for holding them to his mercy.

It would be better to organize these studies as conferences given by eye-witnesses or even victims of V.M. These witnesses could be found without difficulty among North V.N. refugees, formerly V.M. public officials or agents having been liquidated without any reason after years of unflinching devotion.

b. Recalling 1000 years of Chinese domination. Domination which will not fail to recur under another form not less tyrannic with a communist or a V.M. regime.

But a discrimination must be made between the Chinese who want to submit Viet Nam and those who behave as good citizens and participate to the building of a free and independent Viet-Nam.

c. In making every endeavour to help civil authorities to achieve, as soon as possible, social reforms especially agrarian reforms. These reforms are intended to increase the population economical standard of living and they are recommended by the Government "to give everyone something to fight for".

These measures have to be the subject of a propaganda scheme carefully studied by the 2nd and the 5th Bureau of General Staff in conjunction with the Government Political and Economic Services.

These schemes will have to stress on the difference existing between the propaganda communism (in South V.N.) and communism enforced (in North V.N.) and expose clearly the whole insatiable tyranny of V.M. Communism which wants to enslave body and spirit of every man who falls into its claws.

To sum up "with the National Government you dispose of yourself and of your properties".

"With the Communists, your thought itself is overseen".

Be faithful to the Government which defends you and your goods properties.

103
~~SECRET~~
(Vietnamese)

Page determined to be Unclassified
Reviewed Chief, RDD, WHS
IAW EO 13526, Section 3.5
Date: FEB 24 2011

~~SECRET~~

DECLASSIFIED IN FULL
Authority: EO 13526
Chief, Records & Declass Div, WHS
Date: FEB 24 2011

THE LAO NATIONAL ARMY - ITS ROLE IN DEFEATING
COMMUNIST SUBVERSION IN LAOS⁸

Rufus Phillips
Office of the Assistant to the Secretary of Defense
for Special Operations

1. Some Basic Assumptions

a. Winning the support of the Lao people for the Lao government is the single most essential requirement for success in maintaining Lao independence.

b. Communist subversion is now so well-organized and widespread in Laos that a successful counter effort can only be achieved by all-out action in which every available Lao government instrument is used to its maximum capacity.

2. The Enemy

a. The Pathet-Lao enemy in Laos has successfully disguised itself as a champion of the people and as a patriotic force fighting for Lao independence.

b. The enemy has been largely successful in creating a nationwide grass-roots organization composed of about 7,000 ex-Pathet-Lao soldiers from the two northern provinces and an estimated additional 2,000 agents who were in place in the provinces prior to integration.

c. The enemy won an estimated 35 percent of the total vote in the recent elections. The pro-PL vote was particularly high in the more remote areas.

⁸Memorandum, "The Lao National Army - Its Role in Defeating Communist Subversion in Laos," dated 23 July 1958; remarks by Rufus Phillips, III, at a meeting in the Office of Special Operations, Office of the Secretary of Defense, 23 July 1958.

~~SECRET~~

~~SECRET~~

DECLASSIFIED IN FULL
Authority: EO 13526
Chief, Records & Declass Div, WHS
Date: FEB 24 2011

3. The Lao Government

a. Civil Administration: The Lao government civil administration is weak, disorganized and understaffed. There are capable personnel in the provinces but they receive almost no support from the Ministry of the Interior. The civil administration has not been effective in winning the support of the Lao people.

b. The Ministries: Most ministers have been, in the balance, ineffectual. They have not provided the necessary leadership. The ministries are overcentralized and inadequately staffed, lack trained and competent personnel and are unable to carry out their functions in an effective manner. They are plagued by graft and corruption.

c. The Police: The police on the whole are ineffective, corrupt, inexperienced and untrained. They are not respected by the people. With training and more effective leadership the police could be evolved into an effective force, but this process will undoubtedly take several years.

d. Civic Action: Civic Action is the only civilian government service to have penetrated the countryside or to have made a significant contribution toward winning the support of the Lao villager. However, up to the present time, Civic Action has been too new and undersized to accomplish the immense task of winning over the mass of the Lao people. It is extremely doubtful that this organization will be able to accomplish this task alone even if it is expanded in accordance with current plans.

e. The Lao Army (ANL): The ANL is the only trained force of any significant size available to the Lao government. Its 25,000 men are distributed throughout Laos in units down to the county (Tasseng) level. Under the command of the Army is a 16,500-man Auto-Defense force of volunteer units in the villages throughout Laos. In comparison with the Army, the Police contains about 3,000 men, the civil administration (paid) about 100 men, the field services of the ministries (including school teachers) about 1,000 men and Civic Action about 250 men. However the Army is not at the present time sufficiently well-equipped or well-trained to ensure that either its mission of combating external aggression or of assuring internal security can be effectively carried out.

4. The Villages

a. The Lao villages are isolated from each other and from the few existing communication routes. Most of the villages are without schools, roads or public health facilities of any kind.

b. The Lao villager has a great deal of common sense but is ignorant of the outside world, including the rest of his own country. He has heard of American aid but none or little has reached him. He is confronted with the choice of believing in a government which has never done

~~SECRET~~

~~SECRET~~

DECLASSIFIED IN FULL
Authority: EO 13526
Chief, Records & Declass Div, WHS
Date: FEB 24 2011

anything for him and whose representatives in many cases he has never seen, or believing in a Pathet-Lao propaganda agent who lives with him, shares his poverty and promises him better times if he will only cast his vote in support of the Pathet-Lao.

c. The Pathet-Lao are winning in the villages because of the failure of the Lao government to assist the average Lao villager.

5. Summary of the Situation

a. All Lao government agencies have to date been ineffective in meeting the threat of the Pathet-Lao at the village level. The pro-government political parties are even less effective, having no grass-roots political organization. Time is running short. The free Lao have until the 1960 elections to reverse this trend--less than two years.

b. In this situation the only Lao government agency which possesses any real capability for turning the tide at the village level is the Army. Others, particularly Civic Action, can play major roles, but the brunt of the task must fall upon the Army.

6. Assessment of the ANL

a. The ANL possesses some able leaders. These leaders have been rising on the basis of their merit and should assume almost complete control of the ANL in the near future, permitting the elimination of less desirable elements. These leaders are firmly convinced that the ANL must undertake Civic-Action-type projects to win the support of their people, and they will attempt to undertake such projects whether supported by the U.S. or not, since they believe that their survival depends upon it.

b. The ANL is the least corrupt element of the Lao government. Corruption is confined primarily to the chiefs of the major services, quartermaster, etc., and some military regional commanders.

c. The ANL is almost 100 percent loyal to its leaders, who are in turn loyal to the government.

d. The ANL officer corps has been reoriented over the past two years toward their internal security mission, which involves as a necessary first step the winning of the support and respect of the people.

e. On the other hand ANL equipment, which was originally cast-off French equipment, has steadily deteriorated since the end of the Indo-Chinese War. All maintenance--in fact, all technical services--were in French hands when the war ended, few Lao having been trained. Since the war, almost no Lao have been trained in the fields of ordnance, automotive maintenance, communications maintenance, etc.; neither has any new equipment been furnished.

~~SECRET~~

~~SECRET~~

DECLASSIFIED IN FULL
Authority: EO 13526
Chief, Records & Declass Div, WHS
Date: FEB 24 2011

f. In a country where air transportation must be utilized in most areas, the Lao Army has been operating with six C-47 aircraft, only half of which are in a condition to fly missions at any one time. All other aircraft are obtained by civilian contract, which is a costly arrangement. The Lao Army has no helicopters in which to visit isolated North Vietnamese border posts, some of which are more than seven days' march away from the nearest light-aircraft airstrip. Lack of adequate air support renders the Lao Army virtually immobile.

g. The morale and combat efficiency of the ANL have deteriorated since the end of the war, primarily because the troops have been inactive and have had no training.

h. The ANL soldier and many of the officers are not well-informed and cannot match their Pathet-Lao counterparts in the field of propaganda or village-level public relations.

i. The ANL does not possess either a competent intelligence or a competent psychological warfare arm at the present time.

j. End-use observer reports during the recent pre-election period have confirmed the fact, previously reported by the ANL, that Army units were without uniforms, without shoes, equipped with 50-percent defective firearms and ammunition, without communications equipment or vehicles and in such deplorable condition in regard to their basic equipment that they could not effectively combat an armed invasion or successfully win the support of the people.

k. Nevertheless, the ANL is a potential force which, if properly equipped and given a minimum of training, could defeat the communists at the village level in Laos. The ANL represents over a hundred-million-dollar investment to the United States. With very little more but a change in the direction and method of our support, we could make this investment pay off. To obtain success, we must be willing to make an extraordinary effort.

7. Assessment of U.S. Support to date

a. Limited by the terms of the Geneva Agreement, the United States has attempted to give the Lao Army the support it needs by establishing a civilian mission (PEO) within the USOM. This mission has been consistently understaffed with older personnel, mostly retired military officers, none of whom have been able to speak French. To date only one officer in the entire ANL speaks passable English. He is currently about to enroll in our Command and General Staff School at Leavenworth.

b. Lao officers have traveled in Southeast Asia. They have been particularly impressed with what has been accomplished by American

~~SECRET~~

~~SECRET~~

DECLASSIFIED IN FULL
Authority: EO 13526
Chief, Records & Declass Div, WHS
Date: FEB 24 2011

MAAGs and American training methods in Vietnam and the Philippines. They desire to have the type of support which a MAAG can give. They cannot understand why the United States cannot place American military personnel in civilian clothes in Laos to perform the functions of a MAAG.

c. Effective U.S. support has in the past been complicated by the fact that we could not assume the training mission for the ANL, which has been and still is invested in the French. Recent events indicate, however, that the French are much more amenable to our assuming a more active role in this field.

d. U.S. support has been particularly defective in giving the Lao Army what it needs to meet the special nature of the situation in Laos. Too much attention has been paid to rigid T/O and E's, which were made up without due regard to the over-all problems--political and economic as well as military--involved in ensuring internal security as well as guarding against outside aggression. Too often plans have been made for the Lao Army without consulting the Lao themselves.

8. Mission of the Lao Army

a. The Lao Army has two basic missions: to defend Laos against external aggression and to ensure internal security. It has been customary in the past to consider the first of the above missions the primary mission. However, time and events have dictated a change in thinking by demonstrating that Laos could be taken by the communists through internal subversion alone with no armed intervention from the outside.

b. The United States has now partly changed the emphasis of its support to better assist the Lao Army in its internal security mission. Yet we have not gone nearly far enough in ensuring that the Lao Army can and will take the essential first step to internal security which is that of winning the loyalty and support of the people. Support of programs and actions designed to win the people are balked at because it involves the Lao Army in "civilian" operations, i.e., medical assistance to the population, public works projects, relief to meet emergencies, propaganda at civilians and so forth.

c. Objections to the Lao Army's doing this type of work center about the point that it is not "military." We sometimes forget that in the early days of our own country it was our own Army Engineers who built many of the roads, bridges, dams and levees for the public and that even today our Armed Forces are used without any hesitation for emergency relief work in disaster areas. How necessary it is then in a country like Laos that the Army do this type of work, since it is often the only government agency capable of meeting the needs of the people.

d. It is felt in some quarters that for an Army to engage in assistance to the civilian population somehow detracts from the successful

~~SECRET~~

~~SECRET~~

DECLASSIFIED IN FULL
Authority: EO 13526
Chief, Records & Declass Div, WHS
Date: FEB 24 2011

accomplishment of its military mission. To the contrary, such work adds to military success by creating support for the army among the civilian population, which in turn produces voluntary intelligence about the enemy which cannot be acquired in any other fashion. Moreover, a spirit of resistance is generated in the people which can be more formidable in a country like Laos to an invading enemy than any number of regular troops.

e. To successfully accomplish its internal and external security missions, the Lao Army desires to undertake certain programs, particularly in the field of training, and to reorganize essential parts of the over-all Army structure. This cannot be done without close U.S. support and guidance.

9. Essential Actions for the Lao Army

a. Organization: The Lao Army should be better organized to meet the special problems arising from the internal situation in Laos and Lao geography. The Lao would like to be able to place sufficient territorial units (which they call Volunteer Battalions) in each province to ensure that each district has a company of men. Such an organization is necessary to adequately support the Auto-Defense forces. Other organization changes which should be made to meet the special situation in Laos are: The creation of a single staff position for psychological warfare and troop information at all command levels in the ANL down to and including battalion. Other suggested organizational changes are discussed in subsequent paragraphs.

b. Training Center: All units in the ANL must be restored to a certain standard of military proficiency and discipline if the ANL is to fulfill its assigned missions. A training center should be established as soon as possible, modeled on the Quang Trung Training Center in Vietnam. As already suggested by PEO, the instructor cadre can be trained in Vietnam. Competent advisers should be provided by the U.S. in the form of a mobile training team of active duty officers if a MAAG or its equivalent has not been introduced in Laos in the meantime. The ANL battalions should be rotated through the center, the Volunteer Battalions, whose primary mission is internal security, being given training first. The training must be adapted to Lao conditions and must teach the units how to win the support and loyalty of their own people. It is suggested that any shortages of individual equipment be met at this particular time and that equipment be standardized so that these units can return to their assigned areas in good condition.

c. Officer Training: A separate course should be established at the training center to bring all officers and noncommissioned officers in the ANL up to the same level of proficiency. This course would be very similar in nature to the one which was so successful in the Vietnamese Army. At the same time, the present officers' school at Dong Hene should be improved and the rhythm of the school stepped up to provide more officers for the ANL which is now desperately shorthanded.

110
~~SECRET~~

~~SECRET~~

DECLASSIFIED IN FULL
Authority: EO 13526
Chief, Records & Declass Div, WHS
Date: FEB 24 2011

d. Model Unit: A model and demonstration unit should be made out of a battalion stationed at the training center specifically for this purpose. The use of a model unit in Vietnam was particularly successful in raising the general standards of the whole Vietnamese Army.

e. Engineer Construction Battalions: Engineer construction battalions should be created similar in organization and mission to the engineer construction battalions of the Philippine Army which were used so successfully by Magsaysay in his campaign against the Huks. One battalion might be created per military region with sufficient heavy equipment to build roads and sufficient sawmill companies to supply the housing and administrative needs of the Army and at the same time to make a significant contribution to the well-being of the people by building schoolhouses, etc. Such units are particularly essential in Laos where the lack of any basic economic development (roads and bridges) prevents the country from being fully unified and makes contact by the government with all of its citizens almost impossible.

f. Technical Services: The technical services of the Lao Army must be made operative if anything is to be accomplished. The technicians project, which provides for the initial introduction of 82 Filipinos, should be implemented as soon as possible. To wait for the last half of Fiscal Year 1959 may be too late. These technicians must find out what the Lao Army needs in the way of spare parts and new equipment, this equipment and spare parts must be provided immediately, and the Lao counterparts must be trained before the Army can be expected to operate in an efficient fashion. The technicians project should remain flexible so that new batches of technicians can be introduced to meet problems and situations not originally foreseeable.

g. Psychological Warfare: The psychological warfare staff of the Lao Army (G-5) and its subsidiary office, the Army Information Service, whose primary function is troop information and education, should be beefed up to undertake extensive consolidation of psywar and troop indoctrination operations. It is suggested that Filipinos who are particularly experienced in these matters be used as advisers in this program. Mobile teams of Americans should be sent in to survey the radio and press facilities of the ANL. Their requests for equipment should be met promptly. The training of selected officers in psywar operations should be undertaken in Vietnam, the Philippines, Okinawa (radio) and United States.

h. G-2 Operations: The Lao Army lacks experience and training in combat intelligence. A training program should be initially established for battalion-level intelligence officers. It is suggested that a Lao training cadre be formed by sending a number of Lao officers to the Vietnamese Army intelligence school. When the training program is established, a small mobile training team of either Americans or Filipinos should be provided to supervise the training. Once intelligence operations have

~~SECRET~~

~~SECRET~~

been improved in the battalions, higher level training can be given. It is recommended, however, that some U.S. and third-country training be given now to selected staff officers in the G-2 headquarters.

i. Special Forces (Scout-Rangers): A special-forces type of unit should be established as soon as possible in the Lao Army. Such a unit has been requested by the Lao who desire to reform a second parachute battalion out of existing elements within the Army. (Contrary to the impression which may have been gathered, the Lao do not desire to up the over-all strength of the Army by an additional parachute battalion; they simply want to reform the battalion out of existing elements.) This second parachute battalion would serve as cover for the special forces unit, which would initially be company size. The special forces unit as envisaged by the Lao, would closely resemble the Scout-Ranger units of the Philippine Army. It would have its own independent communications and would be capable of carrying out extended combat and intelligence missions deep in hostile territory. These units have been particularly useful in the Philippines against a subversive communist enemy. In case of an overrun by invading enemy forces, this unit would, of course, form the nucleus for the organization of guerrilla warfare. However, its primary mission would be to counter PL subversion in the current cold war. Some eight Lao have already been trained in the Philippine Scout-Ranger course. Sufficient Americans and Filipinos are now on hand in Laos to begin the organization of such a unit. What is needed is authorization from PEO to the ANL for the formation of this unit and the necessary construction of a training area.

j. Auto-Defense: The Auto-Defense should be boosted to its full 25,000-man strength as soon as it is feasible to do so. A major effort should be made to make this force as effective as possible. Some of the other proposed programs (unit training and psywar) will be of particular assistance in the Auto-Defense program. It is recommended that a special mobile training team composed of Americans with some knowledge of self-defense systems in Southeast Asia be dispatched to Laos to inspect the Lao Auto-Defense effort, give on-the-spot advice and make recommendations for improving U.S. support of this operation. The successful extension of the Auto-Defense is in itself an important part of the over-all program of the Lao government to win the support of its people. The Auto-Defense is one of the most successful ways in which the ANL can influence the population, since it is part of the population. Part of the duties of the Auto-Defense consists in carrying out community projects for their particular village and distributing propaganda among the villagers.

k. The Veterans: In Laos the veterans are a hard core of resistance to the Pathet-Lao among the civilian population. These veterans are scattered throughout the villages of Laos. Many of them have been recruited as Auto-Defense personnel. However, the Lao Ministry of Defense has no coherent veterans policy, and although they have reorganized their Veterans' Board at the instigation of a representative of the Philippine

~~SECRET~~

~~SECRET~~

DECLASSIFIED IN FULL
Authority: EO 13526
Chief, Records & Declass Div, WHS
Date: FEB 24 2011

Veterans Legion, they have failed to carry out any programs which are meaningful to the veterans. During the last election, mishandling of various disabled veterans' and survivors' claims by the Ministry of National Defense cost the government votes in several areas. In order to win and keep the loyalty of these veterans, the budget of the Veteran's Board in the Ministry of National Defense should be examined and an attempt made to guide its operations. One worth-while project of great psychological value which would not cost a great deal would be the creation of a small rehabilitation center for amputees similar to the one which is now successfully manufacturing and fitting artificial limbs in Vietnam. There is a high percentage of amputees among Lao soldiers wounded during the war against the Pathet-Lao because of the prevalence of unrecorded mine fields in certain provinces.

l. Commissary System: While the pay of the Lao Army is generally sufficient in the southern and central rural areas, it is marginal in the larger cities such as Vientiane and in the north. The Lao have proposed for several years that commissaries be established in certain key areas to enable military personnel to buy essential food items at reasonable prices. This proposal should receive serious study by some expert qualified to undertake the job. With the advent of monetary reform, it may be necessary to establish commissaries to protect Army personnel on fixed income from speculation by the Chinese and other market manipulators.

m. Civic Action: Civic Action, although a Lao civilian agency program, is of primary importance to the Lao Army since its objective is to win the support of the people to the Lao government. The Civic Action teams have been assisted by the Army within its limited means. Civic Action has in turn helped the Army by supplying it with medicine and other items to distribute when it had none. In the original OCB policy paper on Civic Action, Defense was assigned as one of the supporting agencies. It was stated that the Lao Army would provide logistical support for Civic Action. However PEO has not felt itself to be authorized to support ANL transportation costs if the transport was used to support Civic Action, a "civilian" program. It is recommended that this matter be cleared up by requesting PEO to support the transportation costs of Civic Action personnel and materials where ANL transport is involved.

n. Transport: The Lao Army, owing to the lack of a road net and the inaccessibility of its units, must be adequately equipped with transport aircraft in the form of C-47s, L-20s and helicopters. An intensive training program should be undertaken in all aspects of air transport operations. Initially, a group of Filipino technicians could be introduced to actually man the Lao Air Force until the Lao are in a position to take over. The Lao Army must be more mobile to be effective.

~~SECRET~~

~~SECRET~~

DECLASSIFIED IN FULL
Authority: EO 13526
Chief, Records & Declass Div, WHS
Date: FEB 24 2011

10. Essential Actions on the part of the United States:

a. The United States must win a race against time to give the Lao Army the advice and support it needs to carry out certain essential programs vital to the successful execution of its internal security mission. The United States must be particularly effective in assisting the Lao Army to win the support of the population, without which Laos will be lost to the communists.

b. Such an extraordinary need for timely U.S. assistance calls for extraordinary procedures. It is apparent that the introduction of a MAAG may be delayed for some time even after the withdrawal of the ICC from Laos. In the meantime, it is suggested that some procedure be arranged to "sheep-dip" U.S. Army officers into civilian status so that a team of active, dynamic advisers and inspectors can be placed in Laos who will at the same time possess sufficient knowledge of French to communicate with the Laos.

c. It is recommended that some procedure be established for the emergency procurement of MAP items from stocks available in the Far East so that no more than three months' delay is experienced in the receipt of any item. It is essential to avoid the current delay of six months to a year in the receipt of various MAP items. To meet the current and anticipated needs for MAP items generated as a result of the activities of the mobile training teams and of the technicians, procurement should be as effective and almost as swift as it was during the period prior to the recent elections in Laos.

d. As previously mentioned, it is recommended that the Filipino technicians be introduced into Laos immediately so that they can come to grips with the complete chaos existing in the Lao technical and support services in the hope that sufficient vehicles can be placed on the road by next year to keep the Lao Army moving, that sufficient communications equipment can be repaired so that most of the Lao companies will have radio contact with their battalions, etc.

e. The United States, in the form of the country team, must produce an integrated program for the maximum use of the Lao Army in strengthening the Lao government and eliminating the strength of the communists in Laos. This program must conform to a large degree to what the Lao themselves feel must be done in order to save their country. Doctrinaire concepts must be abandoned. Once a joint program has been agreed upon by the Lao, then the United States must be able to give it effective support in materiel, money and advice.

~~SECRET~~